

MAJESTIC

VALENTINO
BY CERAMICHE PIEMME

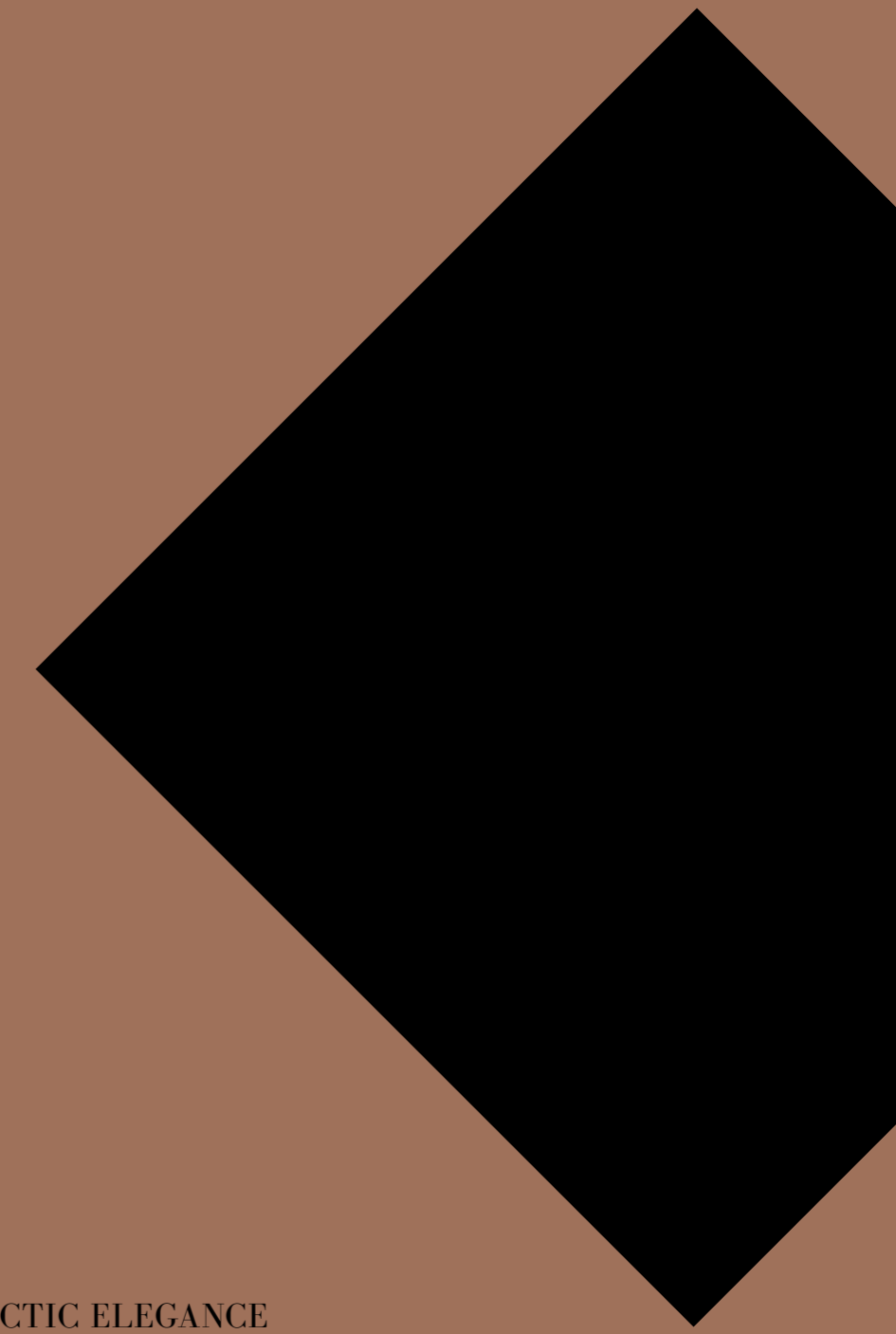

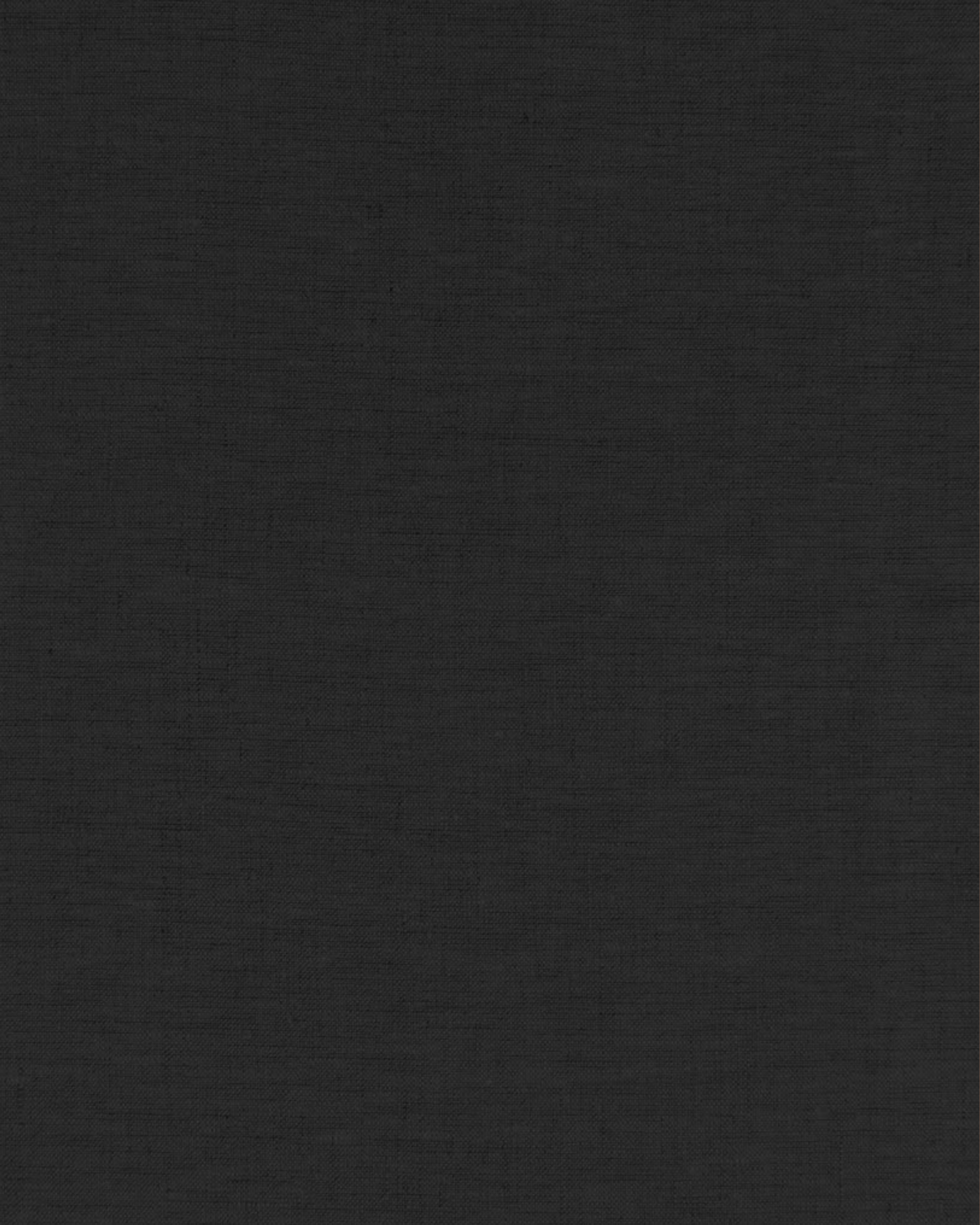

IN THE MOOD OF AN ECLECTIC ELEGANCE



The evolution of an idea of style
Evolution eines Stils
L'évolution d'une conception de style

EVOLUZIONE DI UN'IDEA DI STILE





Le nuove superfici effetto marmo di Valentino by Ceramiche Piemme mostrano il loro lato più estroverso, grazie a un mix ricercato di textures, decorazioni e tonalità che attingono dalla tradizione per poi evolverla in un'estetica contemporanea ed esclusiva.

La collezione Majestic conferma un'indole internazionale e cosmopolita, la vocazione all'accoglienza e l'apertura su un mondo che si espande, con la promessa di regalare una bellezza autentica, profondamente radicata in un "saper fare" che è proprio di un'innata cultura Made in Italy. Fascino da custodire e tramandare per una gamma ricca ed articolata di superfici che attraversano spazi residenziali e commerciali, con accenti "glamour" dallo stile inconfondibile, ricercati e curati in ogni minimo dettaglio.

The new Valentino by Ceramiche Piemme marble effect surfaces show off their wilder side, thanks to a stylish mixture of textures, decorations and shades that develop all the positive elements of tradition to create an exclusive, contemporary look.

The Majestic collection confirms the brand's international and cosmopolitan identity, its vocation for creating welcoming atmospheres and its broad outlook towards an expanding world, promising to provide us with an authentic beauty, deeply rooted in the natural "savoir-faire" of its innate Made in Italy culture.

A charm to be treasured and passed on, in a rich, structured range of surfaces designed to decorate residential and commercial spaces, with hints of "glamour", an unmistakable style and a careful focus on all aspects of the products, including the tiniest details.



Dank einer auserlesenen Mischung von Texturen, Dekors und Farben, die aus der Tradition schöpfen und sich dann mit zeitgenössischer, exklusiver Ästhetik entfalten, zeigen die neuen Oberflächen mit Marmoroptik von Valentino by Ceramiche Piemme mehr als je zuvor ihre extrovertierte Seite.

Die Kollektion Majestic ist eine Bestätigung der internationalen, kosmopolitischen Wesensart, der Berufung zur Aufnahme und der Öffnung auf eine, sich erweiternde Welt, mit dem Versprechen, echte Schönheit zu verleihen, die tief im "Können" der angeborenen Kultur des Made in Italy verwurzelt ist.

Zu wahrer und zu überliefernder Zauber für ein Sortiment mit vielen verschiedenen Oberflächen, die sich für Wohn- und Geschäftsräume eignen, mit "glamourösen" Akzenten unverkennbaren Stils, die auserlesen und bis auf die kleinsten Details gepflegt sind.



Les nouvelles finitions imitation marbre de Valentino by Ceramiche Piemme dévoilent leur côté plus extraverti, dans un mélange raffiné de textures, décorations et tonalités qui s'inspirent de la tradition pour la transformer en esthétique contemporaine et exclusive.

La collection Majestic affirme son tempérament international et cosmopolite, sa vocation pour l'accueil et son ouverture sur un monde qui grandit, avec la promesse d'une beauté authentique, profondément ancrée dans un « savoir-faire » propre à la culture innée du Made in Italy.

Un charme à protéger et à transmettre pour une collection riche et éclectique de surfaces qui habillent les cadres résidentiels et commerciaux avec des touches « glamour », reconnaissables entre mille, élégantes et soignées dans les moindres détails.



Elegance with eternal charm
Eleganz mit unvergänglichem Reiz
Élégance au charme intemporel

ELEGANZA DAL FASCINO ETERNO







ATMOSFERE LUMINOSE
E SOFT

Light-filled and soft atmospheres / Strahlende,
nuancierte Atmosphären / Ambiances
lumineuses et chaleureuses



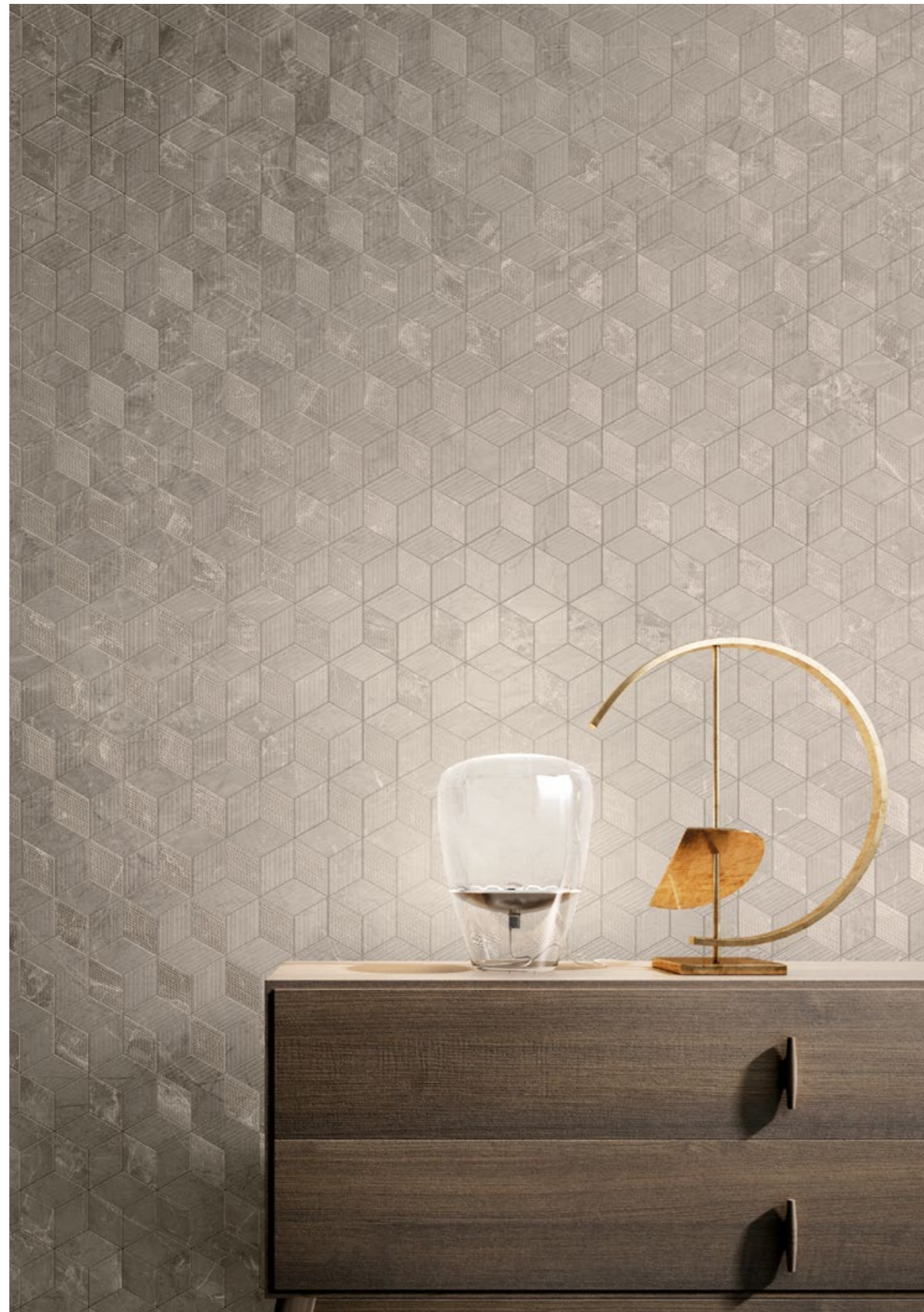

CUBE SUPREME GREY NAT 30x30 - 12"x12"



SUPREME GREY LEV/RET 119,5x119,5 - 47^{1/8}"x47^{1/8}"



New ways of bringing classic style home
Neue Arten klassischen Wohnens
Nouvelles façons d'habiter le classique

NUOVI MODI DI ABITARE IL CLASSICO







ROYAL NERO NAT/RET 60x60 - 24"x24"



MOSAICO JUNGLE WARM LEV 30x30 - 12"x12"





SUPREME GREY NAT/RET 60x119,5 - 24"x47^{1/8"}
 MAJESTIC HIVE PEARL RET 40x120 - 16"x48"



Brand new weaves of materials and décor
Noch nie gesehene Verflechtungen von Materie und Dekor
Enchevêtrements inédits entre matière et décor

INTRECCI INEDITI DI MATERIA E DÉCOR





Una “rivoluzione gentile” passa attraverso la bellezza di superfici che escono dall’ordinario, per mostrarsi in spazi eleganti, costruiti attraverso un cross-over di intrecci stilistici che parlano linguaggi evoluti, propri di chi cerca con consapevolezza e gusto un design d’interior che sappia distinguersi. Majestic rappresenta la massima espressione di una creatività senza confini: una collezione fresca, coinvolgente ma anche curiosa e profonda nel contemplare un universo di spazi e modi di abitare. Siamo ospiti privilegiati di un racconto che parla di residenze d’autore e hotel di lusso, per scoprire il loro lato più intimo e privato, rivelando scenari sempre più fluidi, condivisibili e qualificati.

A “gentle revolution” passes through the beauty of surfaces that step out of the ordinary to reveal themselves in elegant spaces, in a cross-over of stylistic weaves that speak the sophisticated languages of those who invest experience and good taste in seeking a unique interior design. Majestic is the ultimate expression of a kind of creativity without limits: a cool collection, engaging but also curious and capable of contemplating a universe of living spaces and moods with a strong level of intensity. We are privy to a story that speaks of residences d’auteur and luxury hotels, ready to discover their more intimate and private side, to uncover scenarios that are increasingly fluid, shareable and distinguished.

Eine “sanfte Revolution” dank der Schönheit außergewöhnlicher Oberflächen, die sich in eleganten Räumen zur Schau stellen, als Ergebnis einer Kreuzung stilistischer Verflechtungen, die fortschrittliche Sprachen sprechen, genauso wie diejenigen, die bewusst und mit Geschmack nach einem Interior Design suchen, das sich hervorzutun weiß. Majestic verkörpert den höchsten Ausdruck grenzenloser Kreativität: Eine frische, mitreißende Kollektion, die aber auch neugierig und tiefgründig in der Betrachtung eines Universums von Wohnräumen und Arten des Wohnens ist. Wir sind bevorzugte Gäste einer Erzählung, die von Designerwohnungen und Luxushotels schildert und verfließende, gemeinsam nutzbare und qualifizierte Szenarien offenbart.

Une « révolution gentille » passe par la beauté de surfaces sortant de l’ordinaire, pour faire montre d’elles dans des cadres élégants, composés d’un enchevêtrement de styles qui parlent des langages évolués, pour tous ceux qui recherchent sciemment une décoration d’intérieur en mesure de se différencier. Majestic représente la plus belle expression d’une créativité illimitée : une collection fraîche, séduisante, à la fois curieuse et profonde dans son univers des lieux et façons d’habiter. Nous sommes les spectateurs privilégiés d’une histoire qui parle de maisons d’auteur et d’hôtels de luxe. Nous découvrons leur côté plus intime et plus privé par des scénarios qui deviennent fluides, partageables et qualifiés.



Creativity in the name of style
 Kreativität im Zeichen des Stils
 Créativité sous le signe du style

CREATIVITÀ NEL SEGNO DELLO STILE

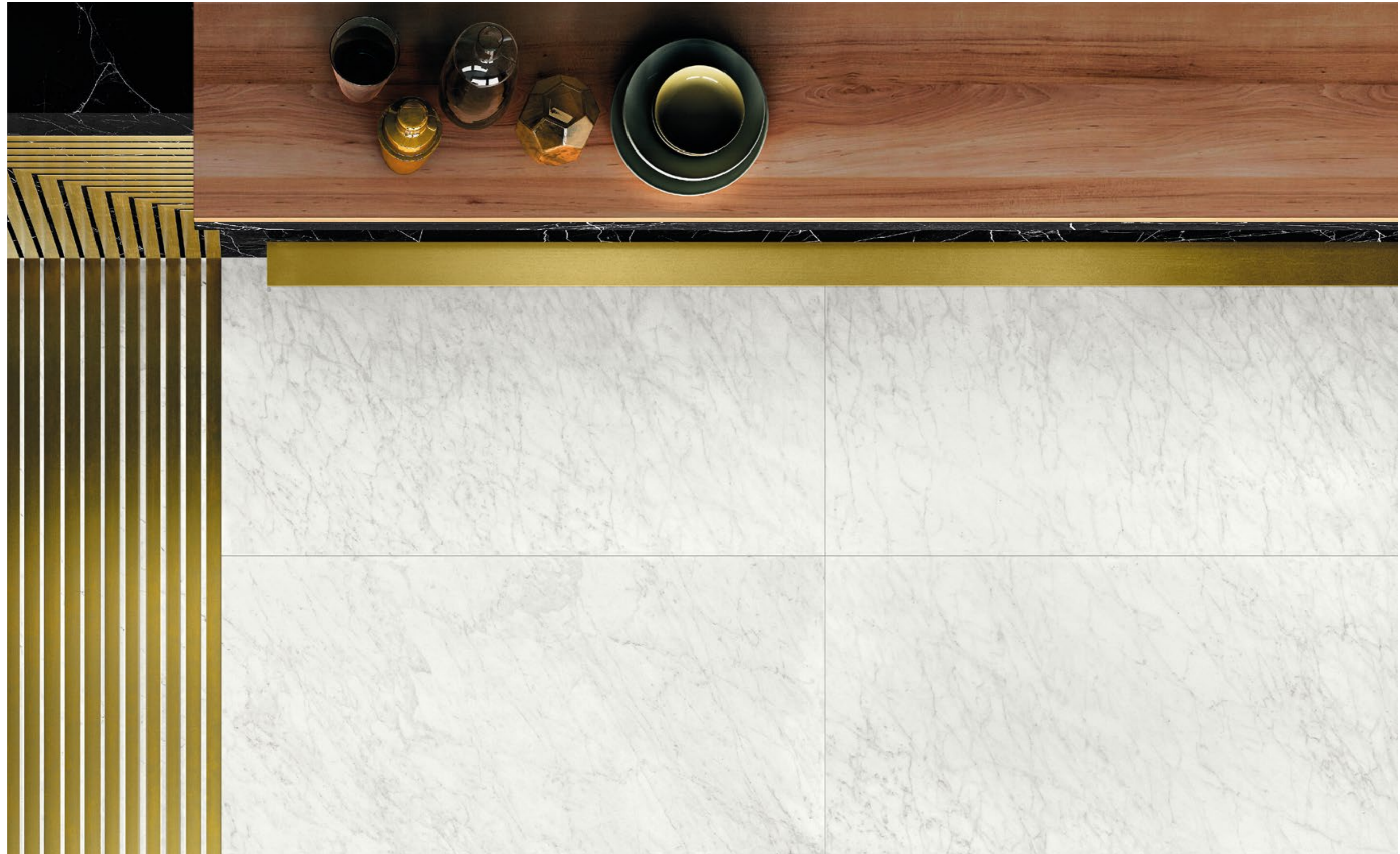

APUANIAN WHITE NAT/RET 60x119,5 - 24"x47"⁸⁰
ROYAL NERO LEV/RET 60x119,5 - 24"x47"⁸⁰



GEOMETRIE PREZIOSE PER
CONTRASTI DECISI

Precious geometries for bold contrasts / Edle
Geometrien für starke Kontraste / Superbes
géométries pour des contrastes nets





MAJESTIC ARROWS COLD LEV 28x32,5 - 11"x12^{3/4}"



A harmony of textures and atmospheres /
Harmonie von Texturen und Atmosphären /
Harmonie de textures et d'ambiances

ARMONIA DI TEXTURES E ATMOSFERE



SUPREME GREY NAT/RET 60x119,5 - 24"x47^{1/8}"
BRICK STRIPES/ BRICK VELVET/ BRICK SUPREME GREY NAT/RET 7,5x30 - 3"x12"
MAJESTIC ONYX RET 40x120 - 16"x48"



SUPREME GREY NAT/RET 60x119,5 - 24"x47"^{1/8}
 BRICK STRIPES/ BRICK VELVET/ BRICK SUPREME GREY NAT/RET 7,5x30 - 3"x12"



SUPREME GREY NAT/RET 60x119,5 - 24"x47"^{1/8}
 MAJESTIC ONYX RET 40x120 -16"x48"



UN RAFFINATO MAKE-UP
D'INTERNI

A stylish interior design make-up /
Geschmackvolle Gestaltung der Innenräume /
Une délicate déco d'intérieur





Refined, eccentric precision
Kultivierte, exzentrische Strenge
Rigueur éclairée et excentrique

RIGORE COLTO ED ECCENTRICO





MAJESTIC ONYX NAT/RET 60x60 - 24"x24"
CHEVRON ROYAL NERO NAT/RET 10x53 - 4"x20"
CHEVRON MAJESTIC ONYX NAT/RET 10x53 - 4"x20"

◇ NATURALEZZA SENZA CONFINI.

Spontaneity without limits / Grenzenlose
Natürlichkeit / Un naturel sans limites





APUANIAN WHITE RET 40x120 - 16"x18"
 MAJESTIC JEWEL FLOWERS RET 40x120 - 16"x48"
 GUAM BLACK LEV/RET 119,5 x 119,5 - 47¹¹/₁₆"x 47¹¹/₁₆"



Original and exclusive design
Kreatives, exklusives Design
Design original et exclusif

DESIGN ORIGINALE ED ESCLUSIVO



GLAM BLACK NAT/RET 60x119,5 - 24"x47"^{18"}
APUANIAN WHITE RET 40x120 - 16"x47"^{18"}
MAJESTIC EMBEDDED COLD LEV/RET 30x60 - 12"x24"



GLAM BLACK NAT/RET 60x119,5 - 24"x47"^{1/8}"
GLAM BLACK LEV/RET 30x60 - 12"x24"
MAJESTIC EMBEDDED COLD LEV/RET 30x60 - 12"x24"





CHEVRON APUANIAN WHITE/CHEVRON ROYAL NERO LEV/RET 10x53 - 4"x20"
 ROYAL NERO LEV/RET 60x119,5 - 24"x47^{1/8}"

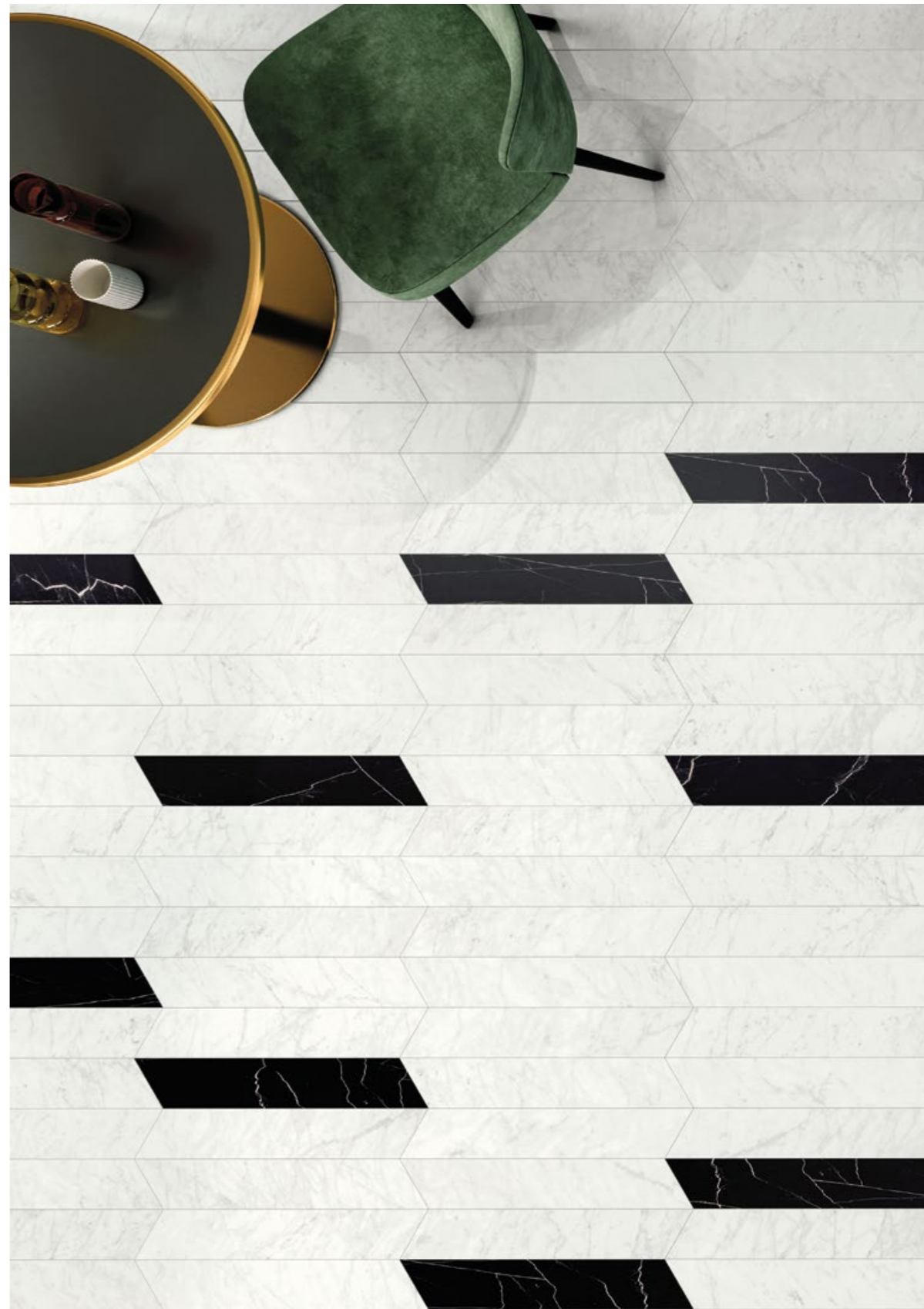

CHEVRON APUANIAN WHITE/CHEVRON ROYAL NERO LEV/RET 10x53 - 4"x20"



HEXAGON ROYAL NERO LEV 34x36 - 13^{3/8}"x14^{1/8}"

Charm that oozes with perfection
Zauber mit einer Note Perfektion
Un charme qui a l'odeur de la perfection

FASCINO CHE PROFUMA DI PERFEZIONE





Majestic interpreta i marmi più pregiati esistenti in natura coniugando la loro estetica raffinata con le qualità tecniche superiori proprie del gres porcellanato. Da sempre i marmi suggeriscono contesti abitativi dal sapore aristocratico o spazi più contemporanei con accenti lussuosi o eclettici, ma pur sempre molto personali, caratterizzati da un mix equilibrato tra stile classico e moderno, eccentricità e linearità. La varietà della collezione permette di esplorare la diversità di questi habitat, attraverso un viaggio in spazi accomunati tutti dalla voglia di rendere omaggio al marmo ed alla sua eterna bellezza, secondo uno stile sofisticato firmato Valentino by Ceramiche Piemme.

Majestic interprets the finest marbles existing in nature by combining their refined appearance with the superior technical qualities of porcelain stoneware. Marbles have always suggested living environments of aristocratic taste or more contemporary interiors with luxury or eclectic accents, but always highly personal and distinguished by a balanced mix of classic and modern style, eccentricity and linearity. The variety of the collection permits exploring the diversity of these habitats, by travelling through interiors which all have in common the desire to pay tribute to marble and its eternal beauty, according to the sophisticated Valentino by Ceramiche Piemme style.



Majestic interpretiert die edelsten, in der Natur vorkommenden Marmore und vereint ihre vornehme Ästhetik mit den technischen Hochleistungseigenschaften von Feinsteinzeug. Seit jeher ist Marmor Inspiration für noble Wohnkontexte oder zeitgenössischere Räumlichkeiten mit luxuriösen oder eklektischen Akzenten, die aber stets sehr individuell gestaltet und durch eine ausgewogene Harmonie von klassischem und modernem Stil, Außergewöhnlichkeit und Linearität geprägt sind. Die Vielfalt der Kollektion ermöglicht es, die Unterschiedlichkeit dieser Umfelder anhand einer Reise durch Räume zu erkunden, die alle den Marmor und seine zeitlose Schönheit im ausgesuchten Valentino Designerstil by Ceramiche Piemme zelebrieren möchten.



Majestic interprète les marbres les plus précieux présents dans la nature en alliant leur beauté raffinée aux hautes propriétés techniques typiques du grès cérame. Depuis toujours le marbre suggère des intérieurs au style aristocratique ou des volumes plus modernes avec des touches luxueuses ou éclectiques, mais toujours très personnelles, en équilibre entre classique et contemporain, excentricité et épure. L'éclectisme de cette collection permet d'explorer les styles les plus divers, à travers un parcours dans des lieux unis par la célébration du marbre et de sa beauté intemporelle, selon le style signé Valentino by Ceramiche Piemme.





QUEEN'S TIARA LEV/RET 60x119,5 - 24"x47^{1/8}"



An eclectic and luxury mix
 Eklektischer, luxuriöser Stil
 Un mix éclectique et luxueux

UN MIX ECLETTICO E LUSSUOSO



ONYX LEV/RET 60x119,5 - 24"x47"^{18M}
 JUNGLE COLD LEV/RET 60x119,5 - 24"x47"^{18M}
 TABLE TOP: ROYAL NERO NAT/RET 60x60 - 24"x24"





ONYX LEV/RET 60x119,5 - 24"x47^{1/8}"
 TABLE TOP: ROYAL NERO NAT/RET 60x60 - 24"x24"



MAJESTIC ONYX FIRMA LEV/RET 30x60 - 12"x24"
 MAJESTIC ONYX LEV/RET 30x60 - 12"x24"





APUANIAN WHITE LEV/RET 119,5x119,5 - 47^{1/8}"x47^{1/8}"
 STRIPES ROYAL NERO NAT/RET 30x119,5 - 12"x47^{1/8}" / MAJESTIC MIX ART LEV/RET 60x119,5 - 24"x47^{1/8}"





ESPANDERE PROSPETTIVE
ED EMOZIONI

Expanding perspectives and emotions /
Perspektive un Emotionen verbreiten /
Magnifier les perspectives et les émotions







PRECIOUS GEM LEV/RET 60x60 - 24"x24"



BRILLANTI ALCIMIE
DI LUCE E DESIGN

Brilliant alchemies of light and design /
Glänzende Vereinigung von Licht und Design /
Brillantes alchimies de lumière et design



MAJESTIC

La ricerca stilistica della collezione Majestic esce volutamente dagli schemi classici di utilizzo delle superfici effetto marmo, per vestire spazi residenziali e commerciali con uno stile eclettico e lussuoso. Un progetto completo ed affascinante per otto essenze eleganti e contemporanee, declinate in numerosi formati e finiture che completano la gamma con un corposo corredo di decorazioni, mosaici e rivestimenti in finissima pasta bianca.

The stylistic research of the Majestic collection deliberately goes beyond the classic patterns of use of marble-effect surfaces, to dress residential and commercial spaces with an eclectic and luxurious style.

A complete and fascinating project for eight elegant and contemporary versions, declined in numerous sizes and finishes which complete the range with a full set of decorations, mosaics and coatings in fine white body.

Die stilistischen Recherchen der Kollektion Majestic gehen mit Absicht über die herkömmlichen Verwendungsmöglichkeiten der Oberflächen mit Marmoroptik hinaus, um Wohn- und Gewerbebereiche in eklektischem, luxuriösem Stil zu verkleiden. Ein komplettes, bezauberndes Projekt für acht elegante, moderne Versionen in zahlreichen Formaten und Finish, die das Sortiment mit einem umfassenden Angebot von Dekors, Mosaiken und Belägen aus feinstem, weißen Scherben ergänzen.

La recherche stylistique de la collection Majestic sort volontairement des sentiers battus de l'utilisation du marbre en céramique, pour revêtir des surfaces résidentielles et commerciales avec un style éclectique et luxueux.

Une collection complète et fascinante composée de huit essences élégantes et modernes, déclinées en de nombreux formats et finitions qui complètent la gamme avec une riche dotation de décorations, mosaïques et revêtements en pâte blanche très fine.

GRES FINE PORCELLANATO
FINE PORCELAIN STONEWARE
FEINSTEINZEUG
GRÈS CÉRAME FIN

PASTA BIANCA RETTIFICATO
WHITE BODY RECTIFIED
WEIßSCHERBIG GESCHLIFFEN
PÂTE BLANCHE RECTIFIÉ

8
COLORI
COLOURS
FARBEN
COULEURS



APUANIAN WHITE



IMPERIAL PEARL



MAJESTIC ONYX

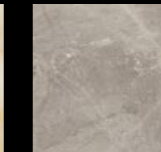

SUPREME GREY



QUEEN'S TIARA



PRECIOUS GEM

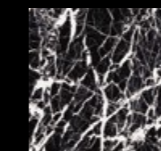

GLAM BLACK



ROYAL NERO

4
COLORI
COLOURS
FARBEN
COULEURS



APUANIAN WHITE



IMPERIAL PEARL



MAJESTIC ONYX



SUPREME GREY

5
FORMATI
SIZES
FORMATE
FORMATS

119,5x119,5 (47^{1/8}"x47^{1/8}")
60x119,5 (24"x47^{1/8}")
60x60 (24"x24")
30x60 (12"x24")
10x53 (4"x20")

1
FORMATI
SIZES
FORMATE
FORMATS

40x120 (16"x48")

2
SPESSORI
THICKNESS
STÄRKE
ÉPAISSEUR

9 9,5

1
SPESSORI
THICKNESS
STÄRKE
ÉPAISSEUR

11

2
SUPERFICI
SURFACES
OBERFLÄCHEN
SURFACES



NATURALE



LEVIGATO

1
SUPERFICI
SURFACES
OBERFLÄCHEN
SURFACES

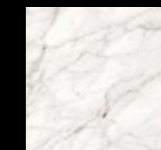

NATURALE

2
STRUTTURE 3D
3D STRUCTURES
STRUKTUREN
DECORATIONS
EN RELIEF



STRIPES



VELVET

1
STRUTTURE 3D
3D STRUCTURES
STRUKTUREN
DECORATIONS
EN RELIEF



HIVE

Rivestimento
Wall tiles
Wandfliesen
Revêtement

Pavimento
Floor tiles
Bodenfliesen
Sol

Rivestimento
Wall tiles
Wandfliesen
Revêtement

MAJESTIC | APUANIAN WHITE

GRES FINE PORCELLANATO
FINE PORCELAIN STONWARE
FEINSTEINZEUG
GRÈS CÉRAME FIN

TECNOLOGIA DIGITALE
DIGITAL TECHNOLOGY
DIGITAL TECHNOLOGY
TECHNOLOGIE NUMÉRIQUE



119,5x119,5
02587 | APUANIAN WHITE LEV/RET ∇ 9

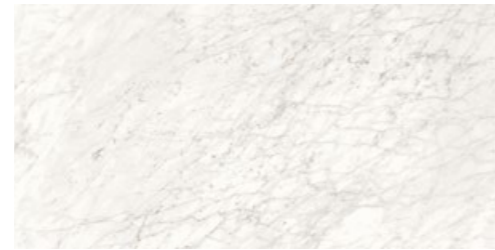

*60x119,5
02582 | APUANIAN WHITE NAT/RET ∇ 9,5
02576 | APUANIAN WHITE LEV/RET ∇ 9,5

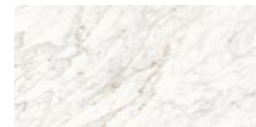

30x60
02548 | APUANIAN WHITE NAT/RET ∇ 9,5
02542 | APUANIAN WHITE LEV/RET ∇ 9,5



*60x119,5
02628 | MAJESTIC ABBEY ROAD A RET
*60x119,5
02629 | MAJESTIC ABBEY ROAD B RET



*60x119,5
02599 | MAJESTIC MIX ART LEV/RET
(mix 2 different decors)



30x119,5
02596 | STRIPES APUANIAN WHITE NAT/RET



*60x119,5
02627 | MAJESTIC JUNGLE COLD LEV/RET
(mix 2 different decors)

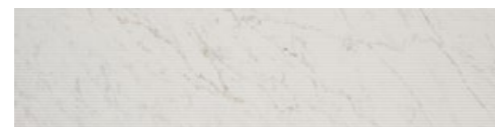

30x119,5
02593 | VELVET APUANIAN WHITE NAT/RET



7,5x30
02638 | BRICK STRIPES APUANIAN WHITE NAT/RET



7,5x30
02635 | BRICK VELVET APUANIAN WHITE NAT/RET



7,5x30
02642 | BRICK APUANIAN WHITE NAT/RET

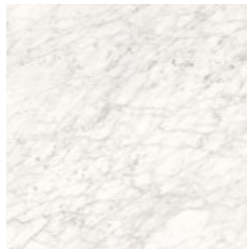

60x60
02569 | APUANIAN WHITE NAT/RET ∇ 9,5
02563 | APUANIAN WHITE LEV/RET ∇ 9,5

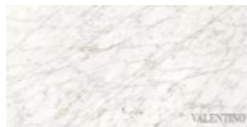

30x60
02678 | APUANIAN WHITE FIRMA LEV/RET ∇ 9,5



10x53
02609 | CHEVRON APUANIAN WHITE NAT/RET ∇ 9,5
02603 | CHEVRON APUANIAN WHITE LEV/RET ∇ 9,5



30x60
02592 | MAJESTIC EMBEDDED COLD LEV/RET
(mix 8 graphics)



34x36
02615 | HEXAGON APUANIAN WHITE LEV



28x32,5
02634 | MAJESTIC ARROWS COLD LEV



31x35
02622 | MAJESTIC NET APUANIAN WHITE LEV



30x30
02645 | CUBE APUANIAN WHITE NAT

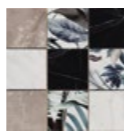

30x30
02632 | MOSAICO JUNGLE COLD LEV

MAJESTIC | APUANIAN WHITE

PASTA BIANCA RETTIFICATO
WHITE BODY RECTIFIED
WEIßSCHERBIG GESCHLIFFEN
PÂTE BLANCHE RECTIFIÉ

TECNOLOGIA DIGITALE
DIGITAL TECHNOLOGY
DIGITAL TECHNOLOGY
TECHNOLOGIE NUMÉRIQUE



40x120
02552 | APUANIAN WHITE RET ∇ 11

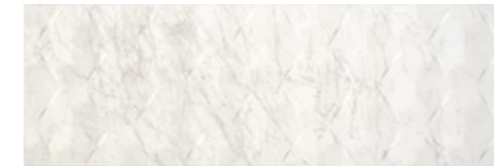

40x120
02556 | MAJESTIC HIVE WHITE RET

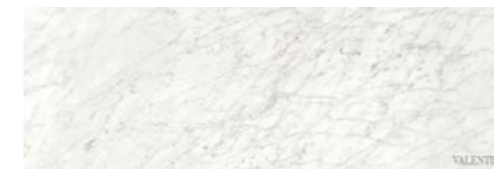

40x120
02683 | APUANIAN WHITE FIRMA RET



40x120
02648 | MAJESTIC JEWEL FLOWERS RET
(mix 2 different decors)



40x120
02589 | MAJESTIC FLOWERS RET
(mix 6 different decors)

* formato modulare con 60x60 e 30x60 / modular size, can be matched with 60x60 and 30x60 size / modulares, spricht mit dem Format 60x60 und 30x60 kombinierbares Format / format modulaire pouvant être coordonné au format 60x60 et 30x60

MAJESTIC | IMPERIAL PEARL

GRES FINE PORCELLANATO
FINE PORCELAIN STONWARE
FEINSTEINZEUG
GRÈS CÉRAME FIN

TECNOLOGIA DIGITALE
DIGITAL TECHNOLOGY
DIGITAL TECHNOLOGIE
TECHNOLOGIE NUMÉRIQUE



*60x119,5
02584 | IMPERIAL PEARL NAT/RET ∇ 9,5
02578 | IMPERIAL PEARL LEV/RET ∇ 9,5



60x60
02572 | IMPERIAL PEARL NAT/RET ∇ 9,5
02565 | IMPERIAL PEARL LEV/RET ∇ 9,5



30x60
02550 | IMPERIAL PEARL NAT/RET ∇ 9,5
02544 | IMPERIAL PEARL LEV/RET ∇ 9,5



30x60
02679 | IMPERIAL PEARL FIRMA LEV/RET ∇ 9,5



*60x119,5
02626 | MAJESTIC JUNGLE WARM LEV/RET
(mix 2 different decors)



*60x119,5
02599 | MAJESTIC MIX ART LEV/RET
(mix 2 different decors)



10x53
02611 | CHEVRON IMPERIAL PEARL NAT/RET ∇ 9,5
02605 | CHEVRON IMPERIAL PEARL LEV/RET ∇ 9,5



30x60
02591 | MAJESTIC EMBEDDED WARM LEV/RET
(mix 8 graphics)



34x36
02617 | HEXAGON IMPERIAL PEARL LEV

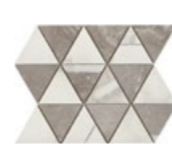

28x32,5
02633 | MAJESTIC ARROWS WARM LEV

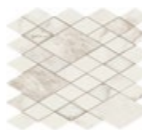

31x35
02624 | MAJESTIC NET IMPERIAL PEARL LEV

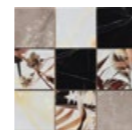

30x30
02631 | MOSAICO JUNGLE WARM LEV

MAJESTIC | IMPERIAL PEARL

PASTA BIANCA RETTIFICATO
WHITE BODY RECTIFIED
WEIßSCHERBIG GESCHLIFFEN
PÂTE BLANCHE RECTIFIÉ

TECNOLOGIA DIGITALE
DIGITAL TECHNOLOGY
DIGITAL TECHNOLOGIE
TECHNOLOGIE NUMÉRIQUE



40x120
02553 | IMPERIAL PEARL RET ∇ 11



40x120
02557 | MAJESTIC HIVE PEARL RET



40x120
02684 | IMPERIAL PEARL FIRMA RET



40x120
02648 | MAJESTIC JEWEL FLOWERS RET
(mix 2 different decors)

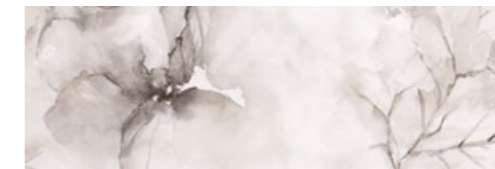

40x120
02589 | MAJESTIC FLOWERS RET
(mix 6 different decors)

* formato modulare con 60x60 e 30x60 / modular size, can be matched with 60x60 and 30x60 size / modulares, spricht mit dem Format 60x60 und 30x60 kombinierbares Format / format modulaire pouvant être coordonné au format 60x60 et 30x60

MAJESTIC | MAJESTIC ONYX

GRES FINE PORCELLANATO
FINE PORCELAIN STONWARE
FEINSTEINZEUG
GRÈS CÉRAME FIN

TECNOLOGIA DIGITALE
DIGITAL TECHNOLOGY
DIGITAL TECHNOLOGIE
TECHNOLOGIE NUMÉRIQUE



*60x119,5
02583 | MAJESTIC ONYX NAT/RET ∇ 9,5
02577 | MAJESTIC ONYX LEV/RET ∇ 9,5

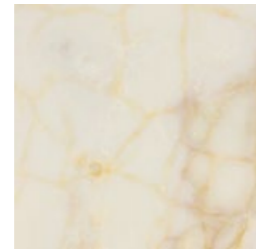

60x60
02571 | MAJESTIC ONYX NAT/RET ∇ 9,5
02564 | MAJESTIC ONYX LEV/RET ∇ 9,5



30x60
02549 | MAJESTIC ONYX NAT/RET ∇ 9,5
02543 | MAJESTIC ONYX LEV/RET ∇ 9,5

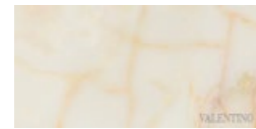

30x60
02681 | MAJESTIC ONYX FIRMA LEV/RET ∇ 9,5



*60x119,5
02626 | MAJESTIC JUNGLE WARM LEV/RET
(mix 2 different decors)

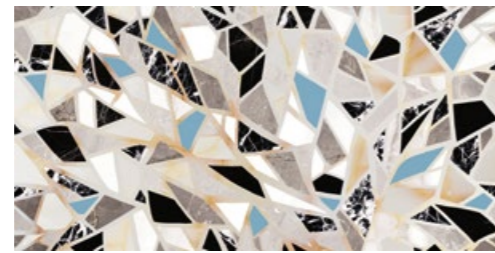

*60x119,5
02599 | MAJESTIC MIX ART LEV/RET
(mix 2 different decors)



10x53
02610 | CHEVRON MAJESTIC ONYX NAT/RET ∇ 9,5
02604 | CHEVRON MAJESTIC ONYX LEV/RET ∇ 9,5



34x36
02616 | HEXAGON
MAJESTIC ONYX LEV



31x35
02623 | MAJESTIC NET
MAJESTIC ONYX LEV

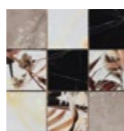

30x30
02631 | MOSAICO
JUNGLE WARM LEV

MAJESTIC | MAJESTIC ONYX

PASTA BIANCA RETTIFICATO
WHITE BODY RECTIFIED
WEIßSCHERBIG GESCHLIFFEN
PÂTE BLANCHE RECTIFIÉ

TECNOLOGIA DIGITALE
DIGITAL TECHNOLOGY
DIGITAL TECHNOLOGIE
TECHNOLOGIE NUMÉRIQUE



40x120
02554 | MAJESTIC ONYX RET ∇ 11



40x120
02558 | MAJESTIC HIVE ONYX RET



40x120
02685 | MAJESTIC ONYX FIRMA RET



40x120
02648 | MAJESTIC JEWEL FLOWERS RET
(mix 2 different decors)



40x120
02589 | MAJESTIC FLOWERS RET
(mix 6 different decors)

* formato modulare con 60x60 e 30x60 / modular size, can be matched with 60x60 and 30x60 size / modulares, spricht mit dem Format 60x60 und 30x60 kombinierbares Format / format modulaire pouvant être coordonné au format 60x60 et 30x60

MAJESTIC | SUPREME GREY

GRES FINE PORCELLANATO
FINE PORCELAIN STONWARE
FEINSTEINZEUG
GRÈS CÉRAME FIN

TECNOLOGIA DIGITALE
DIGITAL TECHNOLOGY
DIGITAL TECHNOLOGY
TECHNOLOGIE NUMÉRIQUE



119,5x119,5
02588 | SUPREME GREY LEV/RET ▽ 9



*60x119,5
02585 | SUPREME GREY NAT/RET ▽ 9,5
02579 | SUPREME GREY LEV/RET ▽ 9,5



30x60
02551 | SUPREME GREY NAT/RET ▽ 9,5
02545 | SUPREME GREY LEV/RET ▽ 9,5



60x60
02573 | SUPREME GREY NAT/RET ▽ 9,5
02566 | SUPREME GREY LEV/RET ▽ 9,5



30x60
02682 | SUPREME GREY FIRMA LEV/RET ▽ 9,5



*60x119,5
02626 | MAJESTIC JUNGLE WARM LEV/RET
(mix 2 different decors)



*60x119,5
02599 | MAJESTIC MIX ART LEV/RET
(mix 2 different decors)



30x119,5
02598 | STRIPES SUPREME GREY NAT/RET



30x119,5
02595 | VELVET SUPREME GREY NAT/RET



7,5x30
02641 | BRICK STRIPES SUPREME GREY NAT/RET



7,5x30
02637 | BRICK VELVET SUPREME GREY NAT/RET



7,5x30
02644 | BRICK SUPREME GREY NAT/RET



10x53
02612 | CHEVRON SUPREME GREY NAT/RET ▽ 9,5
02606 | CHEVRON SUPREME GREY LEV/RET ▽ 9,5



30x60
02591 | MAJESTIC EMBEDDED WARM LEV/RET
(mix 8 graphics)



34x36
02618 | HEXAGON
SUPREME GREY LEV

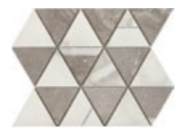

28x32,5
02633 | MAJESTIC
ARROWS WARM LEV



31x35
02625 | MAJESTIC NET
SUPREME GREY LEV



30x30
02647 | CUBE
SUPREME GREY NAT

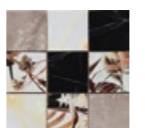

30x30
02631 | MOSAICO
JUNGLE WARM LEV

* formato modulare con 60x60 e 30x60 / modular size, can be matched with 60x60 and 30x60 size / modulares, spricht mit dem Format 60x60 und 30x60 kombinierbares Format / format modulaire pouvant être coordonné au format 60x60 et 30x60

MAJESTIC | SUPREME GREY

PASTA BIANCA RETTIFICATO
WHITE BODY RECTIFIED
WEIßSCHERBIG GESCHLIFFEN
PÂTE BLANCHE RECTIFIÉ

TECNOLOGIA DIGITALE
DIGITAL TECHNOLOGY
DIGITAL TECHNOLOGY
TECHNOLOGIE NUMÉRIQUE



40x120
02555 | SUPREME GREY RET ▽ 11



40x120
02559 | MAJESTIC HIVE GREY RET

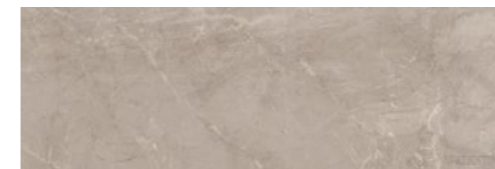

40x120
02686 | SUPREME GREY FIRMA RET



40x120
02648 | MAJESTIC JEWEL FLOWERS RET
(mix 2 different decors)



40x120
02589 | MAJESTIC FLOWERS RET
(mix 6 different decors)

MAJESTIC | QUEEN'S TIARA

GRES FINE PORCELLANATO
FINE PORCELAIN STONWARE
FEINSTEINZEUG
GRÈS CÉRAME FIN

TECNOLOGIA DIGITALE
DIGITAL TECHNOLOGY
DIGITAL TECHNOLOGIE
TECHNOLOGIE NUMÉRIQUE



*60x119,5
02656 | QUEEN'S TIARA NAT/RET
02651 | QUEEN'S TIARA LEV/RET

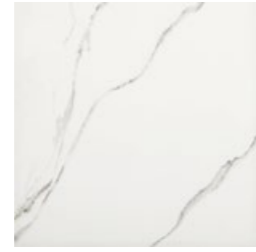

60x60
02655 | QUEEN'S TIARA NAT/RET
02652 | QUEEN'S TIARA LEV/RET



30x60
02654 | QUEEN'S TIARA NAT/RET
02653 | QUEEN'S TIARA LEV/RET

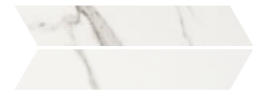

10x53
02659 | CHEVRON QUEEN'S TIARA NAT/RET
02658 | CHEVRON QUEEN'S TIARA LEV/RET



34x36
02660 | HEXAGON
QUEEN'S TIARA LEV



31x35
02661 | MAJESTIC NET
QUEEN'S TIARA LEV

* formato modulare con 60x60 e 30x60 / modular size, can be matched with 60x60 and 30x60 size / modulares, spricht mit dem Format 60x60 und 30x60 kombinierbares Format / format modulaire pouvant être coordonné au format 60x60 et 30x60

MAJESTIC | PRECIOUS GEM

GRES FINE PORCELLANATO
FINE PORCELAIN STONWARE
FEINSTEINZEUG
GRÈS CÉRAME FIN

TECNOLOGIA DIGITALE
DIGITAL TECHNOLOGY
DIGITAL TECHNOLOGIE
TECHNOLOGIE NUMÉRIQUE

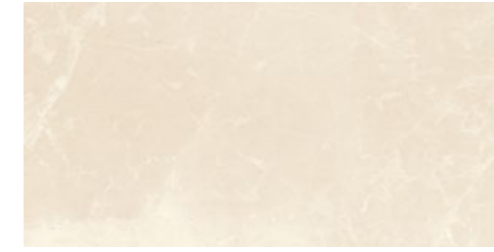

*60x119,5
02665 | PRECIOUS GEM NAT/RET
02662 | PRECIOUS GEM LEV/RET

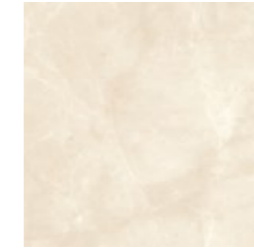

60x60
02666 | PRECIOUS GEM NAT/RET
02663 | PRECIOUS GEM LEV/RET



30x60
02667 | PRECIOUS GEM NAT/RET
02664 | PRECIOUS GEM LEV/RET



10x53
02675 | CHEVRON PRECIOUS GEM NAT/RET
02668 | CHEVRON PRECIOUS GEM LEV/RET



34x36
02676 | HEXAGON PRE-
CIOUS GEM LEV



31x35
02677 | MAJESTIC NET
PRECIOUS GEM LEV

* formato modulare con 60x60 e 30x60 / modular size, can be matched with 60x60 and 30x60 size / modulares, spricht mit dem Format 60x60 und 30x60 kombinierbares Format / format modulaire pouvant être coordonné au format 60x60 et 30x60

MAJESTIC | GLAM BLACK

GRES FINE PORCELLANATO
FINE PORCELAIN STONWARE
FEINSTEINZEUG
GRÈS CÉRAME FIN

TECNOLOGIA DIGITALE
DIGITAL TECHNOLOGY
DIGITAL TECHNOLOGIE
TECHNOLOGIE NUMÉRIQUE

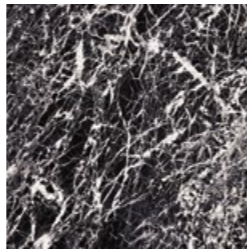
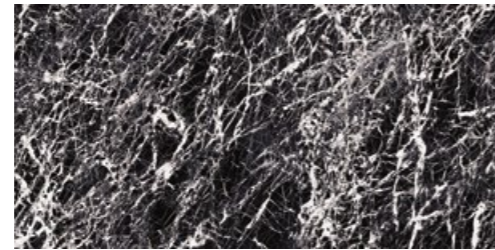
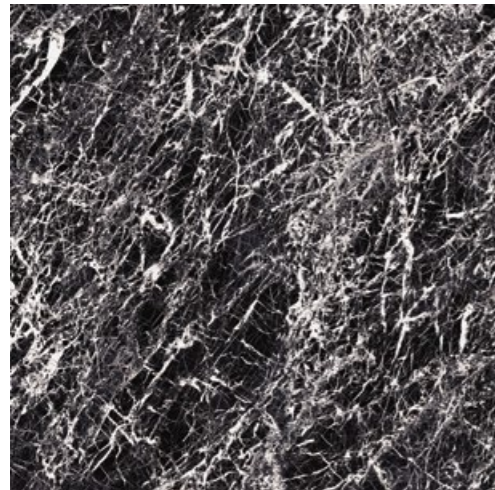

119,5x119,5
02586 | GLAM BLACK LEV/RET ∇ 9



*60x119,5
02581 | GLAM BLACK NAT/RET ∇ 9,5
02575 | GLAM BLACK LEV/RET ∇ 9,5

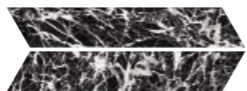

60x60
02568 | GLAM BLACK NAT/RET ∇ 9,5
02562 | GLAM BLACK LEV/RET ∇ 9,5



*60x119,5
02627 | MAJESTIC JUNGLE COLD LEV/RET
(mix 2 different decors)

*60x119,5
02599 | MAJESTIC MIX ART LEV/RET
(mix 2 different decors)

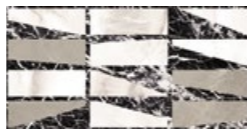

30x60
02592 | MAJESTIC EMBEDDED COLD LEV/RET
(mix 8 graphics)

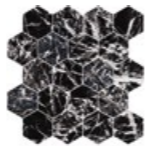

34x36
02614 | HEXAGON
GLAM BLACK LEV



31x35
02621 | MAJESTIC NET
GLAM BLACK LEV

* formato modulare con 60x60 e 30x60 / modular size, can be matched with 60x60 and 30x60 size / modulares, spricht mit dem Format 60x60 und 30x60 kombinierbares Format / format modulaire pouvant être coordonné au format 60x60 et 30x60

MAJESTIC | ROYAL NERO

GRES FINE PORCELLANATO
FINE PORCELAIN STONWARE
FEINSTEINZEUG
GRÈS CÉRAME FIN

TECNOLOGIA DIGITALE
DIGITAL TECHNOLOGY
DIGITAL TECHNOLOGIE
TECHNOLOGIE NUMÉRIQUE

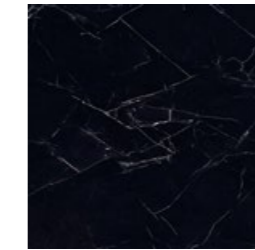

*60x119,5
02580 | ROYAL NERO NAT/RET ∇ 9,5
02574 | ROYAL NERO LEV/RET ∇ 9,5

60x60
02567 | ROYAL NERO NAT/RET ∇ 9,5
02561 | ROYAL NERO LEV/RET ∇ 9,5



30x60
02546 | ROYAL NERO NAT/RET ∇ 9,5
02539 | ROYAL NERO LEV/RET ∇ 9,5



10x53
02607 | CHEVRON ROYAL NERO NAT/RET ∇ 9,5
02601 | CHEVRON ROYAL NERO LEV/RET ∇ 9,5



*60x119,5
02628 | MAJESTIC
ABBAY ROAD A RET



*60x119,5
02599 | MAJESTIC MIX ART LEV/RET
(mix 2 different decors)

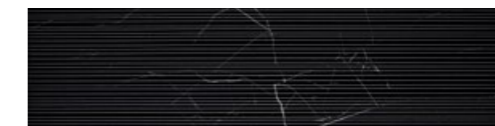

30x119,5
02597 | STRIPES ROYAL NERO NAT/RET



30x119,5
02594 | VELVET ROYAL NERO NAT/RET



7,5x30
02639 | BRICK STRIPES ROYAL NERO NAT/RET



7,5x30
02636 | BRICK VELVET ROYAL NERO NAT/RET



7,5x30
02643 | BRICK ROYAL NERO NAT/RET



*60x119,5
02627 | MAJESTIC JUNGLE COLD LEV/RET
(mix 2 different decors)

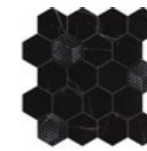

34x36
02613 | HEXAGON
ROYAL NERO LEV



28x32,5
02634 | MAJESTIC
ARROWS COLD LEV

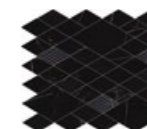

31x35
02619 | MAJESTIC NET
ROYAL NERO LEV



30x30
02646 | CUBE ROYAL
NERO NAT

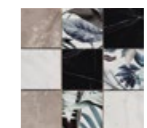

30x30
02632 | MOSAICO
JUNGLE COLD LEV

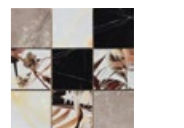

30x30
02631 | MOSAICO
JUNGLE WARM LEV

* formato modulare con 60x60 e 30x60 / modular size, can be matched with 60x60 and 30x60 size / modulares, spricht mit dem Format 60x60 und 30x60 kombinierbares Format / format modulaire pouvant être coordonné au format 60x60 et 30x60

MAJESTIC | SOLUZIONI DI POSA

INSTALLATION SOLUTIONS
VERLEGUNGSVORSCHLÄGE
SOLUTIONS DE POSE

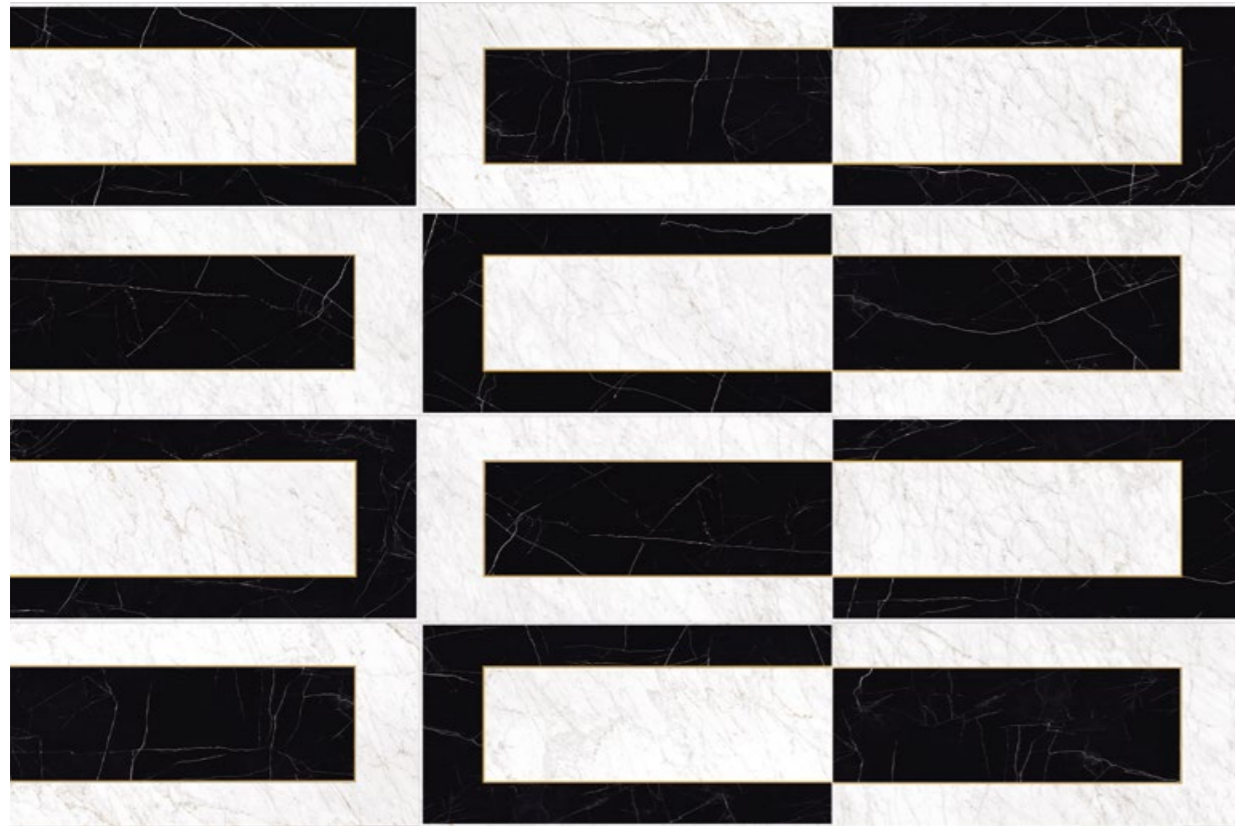

1 MAJESTIC ABBEY ROAD A E B 60x119,5 - 24"x47 1/8"

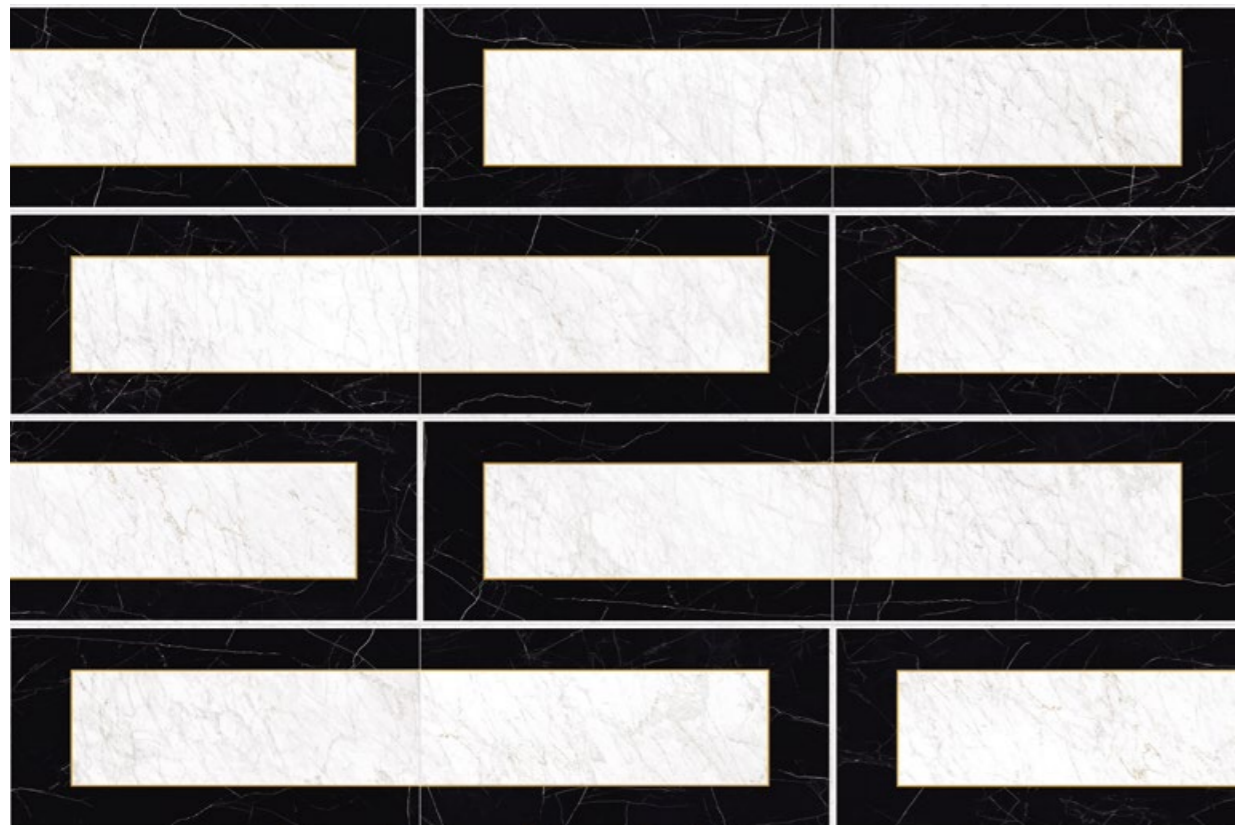

2 MAJESTIC ABBEY ROAD A 60x119,5 - 24"x47 1/8"

MAJESTIC | SOLUZIONI DI POSA

INSTALLATION SOLUTIONS
VERLEGUNGSVORSCHLÄGE
SOLUTIONS DE POSE



3 MAJESTIC ABBEY ROAD B - APUANIAM WHITE NAT/RET 60x119,5 - 24"x47 1/8"



4 MAJESTIC ABBEY ROAD A - APUANIAM WHITE NAT/RET 60x119,5 - 24"x47 1/8"

MAJESTIC

GRES FINE PORCELLANATO
FINE PORCELAIN STONEWARE
FEINSTEINZEUG
GRÉS CÉRAME FIN

TECNOLOGIA DIGITALE
DIGITAL TECHNOLOGY
DIGITAL TECHNOLOGIE
TECHNOLOGIE NUMÉRIQUE

FASCE PREZZO | PRICE RANGE | PREISGRUPPE | NIVEAU DE PRIX

■ FASCIA PREZZO AL METRO QUADRATO / SQUARE METER PRICE RANGE / QUADRATMETER PREISGRUPPE / NIVEAU DE PRIX AU MÈTRE CARRÉ
▲ FASCIA PREZZO AL PEZZO / PRICE RANGE PER PIECE / STÜCK PREISGRUPPE / NIVEAU DE PRIX À LA PIÈCE

FORMAT SIZES	FORMAT SIZES					PEI	DIN 51130	DIN 51097	DCOF	MIX ART 60x119,5 - 24"x47" ¹⁸
	119,5x119,5 - 47" ¹⁸ x47" ¹⁸	60x119,5 - 24"x47" ¹⁸	60x60 - 24"x24"	30x60 - 12"x24"	10x53 - 4"x20"					
	▲ 9	▲ 9,5	▲ 9,5	▲ 9,5	▲ 9,5					▲ 9,5
APUANIAN WHITE	NAT/RET	02582 690	02569 640	02548 600	02609 830	V4	V	R9	A	> 0,42
	LEV/RET	02587 820	02576 770	02563 730	02542 720					
IMPERIAL PEARL	NAT/RET	02584 690	02572 640	02550 600	02611 830	V4	V	R9	A	> 0,42
	LEV/RET	02578 770	02565 730	02544 720	02605 850					
MAJESTIC ONYX	NAT/RET	02583 690	02571 640	02549 600	02610 830	V4	V	R9	A	> 0,42
	LEV/RET	02577 770	02564 730	02543 720	02604 850					
SUPREME GREY	NAT/RET	02585 690	02573 640	02551 600	02612 830	V4	V	R9	A	> 0,42
	LEV/RET	02588 820	02579 770	02566 730	02545 720					
QUEEN'S TIARA	NAT/RET	02656 690	02655 640	02654 600	02659 830	V4	V	R9	A	> 0,42
	LEV/RET	02651 770	02652 730	02653 720	02658 850					
PRECIOUS GEM	NAT/RET	02665 690	02666 640	02667 600	02675 830	V4	V	R9	A	> 0,42
	LEV/RET	02662 770	02663 730	02664 720	02668 850					
GLAM BLACK	NAT/RET	02581 710	02568 680	02547 610	02608 830	V4	IV	R9	A	> 0,42
	LEV/RET	02586 820	02575 790	02562 740	02541 730					
ROYAL NERO	NAT/RET	02580 710	02567 680	02546 610	02607 830	V4	IV	R9	A	> 0,42
	LEV/RET	02574 790	02561 740	02539 730	02601 850					

MAJESTIC

GRES FINE PORCELLANATO
FINE PORCELAIN STONEWARE
FEINSTEINZEUG
GRÉS CÉRAME FIN

TECNOLOGIA DIGITALE
DIGITAL TECHNOLOGY
DIGITAL TECHNOLOGIE
TECHNOLOGIE NUMÉRIQUE

FASCE PREZZO | PRICE RANGE | PREISGRUPPE | NIVEAU DE PRIX

■ FASCIA PREZZO AL METRO QUADRATO / SQUARE METER PRICE RANGE / QUADRATMETER PREISGRUPPE / NIVEAU DE PRIX AU MÈTRE CARRÉ
▲ FASCIA PREZZO AL PEZZO / PRICE RANGE PER PIECE / STÜCK PREISGRUPPE / NIVEAU DE PRIX À LA PIÈCE

FORMAT SIZES	FORMAT SIZES				STRUTTURE 3D 3D STRUCTURES				
	ABBEY ROAD A ABBEY ROAD B 60x119,5 - 24"x47" ¹⁸	JUNGLE 60x119,5 - 24"x47" ¹⁸	EMBEDDED 30x60 - 12"x24"	FIRMA 30x60 - 12"x24"	STRIPES 30x119,5 - 12"x47" ¹⁸	VELVET 30x119,5 - 12"x47" ¹⁸	BRICK STRIPES 7,5x30 - 3"x12"	BRICK VELVET 7,5x30 - 3"x12"	BRICK 7,5x30 - 3"x12"
	▲ 9,5	▲ 9,5	▲ 9,5	▲ 9,5	▲ 9,5	▲ 9,5	▲ 9,5	▲ 9,5	▲ 9,5
APUANIAN WHITE	NAT/RET	02628 861 02629 861			02596 740	02593 740	02638 30	02635 30	02642 30
	LEV/RET		02627 861	02592 740	02678 660				
IMPERIAL PEARL	NAT/RET								
	LEV/RET		02626 861	02591 740	02679 660				
MAJESTIC ONYX	NAT/RET								
	LEV/RET		02626 861 02627 861		02681 660				
SUPREME GREY	NAT/RET				02598 740	02595 740	02641 30	02637 30	02644 30
	LEV/RET		02626 861	02591 740	02682 660				
QUEEN'S TIARA	NAT/RET								
	LEV/RET								
PRECIOUS GEM	NAT/RET								
	LEV/RET								
GLAM BLACK	NAT/RET								
	LEV/RET		02627 861	02592 740					
ROYAL NERO	NAT/RET	02628 861 02629 861			02597 740	02594 740	02639 30	02636 30	02643 30
	LEV/RET		02626 861 02627 861						

MAJESTIC

GRES FINE PORCELLANATO
FINE PORCELAIN STONEWARE
FEINSTEINZEUG
GRÉS CÉRAMÉ FIN

TECNOLOGIA DIGITALE
DIGITAL TECHNOLOGY
DIGITAL TECHNOLOGIE
TECHNOLOGIE NUMÉRIQUE

FASCE PREZZO | PRICE RANGE | PREISGRUPPE | NIVEAU DE PRIX

■ FASCIA PREZZO AL METRO QUADRATO / SQUARE METER PRICE RANGE / QUADRATMETER PREISGRUPPE / NIVEAU DE PRIX AU MÈTRE CARRÉ
▲ FASCIA PREZZO AL PEZZO / PRICE RANGE PER PIECE / STÜCK PREISGRUPPE / NIVEAU DE PRIX À LA PIÈCE

FORMATI SIZES	PEZZI SPECIALI SPECIAL PIECES									
	HEXAGON 34x36 - 13 ^{3/8} "x14 ^{1/8} "	ARROWS 28x32,5 - 11"x12 ^{3/4} "	NET 31x35 - 12 ^{1/4} "x13 ^{3/4} "	CUBE 30x30 - 12"x12"	MOSAICO JUNGLE 30x30 - 12"x12"	GRADINO 30x60 - 12"x24"	GRADINO 30x119,5 - 12"x47 ^{1/8} "	BATTISCOPA 8x60 - 3 ^{1/8} "x24"	BATTISCOPA 6,5x119,5 - 2 ^{1/2} "x47 ^{1/8} "	
	▼ 9,5 ▲ 9,5	▼ 9,5 ▲ 9,5	▼ 9,5 ▲ 9,5	▼ 9,5 ▲ 9,5	▼ 9,5 ▲ 9,5	▼ 9,5 ▲ 9,5	▼ 9,5 ▲ 9,5	▼ 9,5 ▲ 9,5	▼ 9,5 ▲ 9,5	▼ 9,5 ▲ 9,5
APUANIAN WHITE	NAT/RET			02645 ▲ 220		02744 ▲ 200	02760 ▲ 710	02712 ▲ 60	02728 ▲ 130	V4
	LEV/RET	02615 ▲ 680	02634 ▲ 470	02622 ▲ 560		02632 ▲ 470	02736 ▲ 290	02752 ▲ 790	02704 ▲ 130	02720 ▲ 170
IMPERIAL PEARL	NAT/RET					02746 ▲ 200	02762 ▲ 710	02714 ▲ 60	02730 ▲ 130	V4
	LEV/RET	02617 ▲ 680	02633 ▲ 470	02624 ▲ 560		02631 ▲ 470	02738 ▲ 290	02754 ▲ 790	02706 ▲ 130	02722 ▲ 170
MAJESTIC ONYX	NAT/RET					02745 ▲ 200	02761 ▲ 710	02713 ▲ 60	02729 ▲ 130	V4
	LEV/RET	02616 ▲ 680		02623 ▲ 560		02631 ▲ 470	02737 ▲ 290	02753 ▲ 790	02705 ▲ 130	02721 ▲ 170
SUPREME GREY	NAT/RET			02647 ▲ 220		02747 ▲ 200	02763 ▲ 710	02715 ▲ 60	02731 ▲ 130	V4
	LEV/RET	02618 ▲ 680	02633 ▲ 470	02625 ▲ 560		02631 ▲ 470	02739 ▲ 290	02755 ▲ 790	02707 ▲ 130	02723 ▲ 170
QUEEN'S TIARA	NAT/RET					02748 ▲ 200	02764 ▲ 710	02716 ▲ 60	02732 ▲ 130	V4
	LEV/RET	02660 ▲ 680		02661 ▲ 560		02740 ▲ 290	02756 ▲ 790	02708 ▲ 130	02724 ▲ 170	
PRECIOUS GEM	NAT/RET					02749 ▲ 200	02765 ▲ 710	02717 ▲ 60	02733 ▲ 130	V4
	LEV/RET	02676 ▲ 680		02677 ▲ 560		02741 ▲ 290	02757 ▲ 790	02709 ▲ 130	02725 ▲ 170	
GLAM BLACK	NAT/RET					02743 ▲ 200	02759 ▲ 710	02711 ▲ 60	02727 ▲ 130	V4
	LEV/RET	02614 ▲ 680		02621 ▲ 560		02735 ▲ 290	02751 ▲ 790	02703 ▲ 130	02719 ▲ 170	
ROYAL NERO	NAT/RET			02646 ▲ 220		02742 ▲ 200	02758 ▲ 710	02710 ▲ 60	02726 ▲ 130	V4
	LEV/RET	02613 ▲ 680	02634 ▲ 470	02619 ▲ 560		02632 ▲ 470 02631 ▲ 470	02734 ▲ 290	02750 ▲ 790	02702 ▲ 130	02718 ▲ 170

MAJESTIC

PASTA BIANCA RETTIFICATO
WHITE BODY RECTIFIED
WEISSCHERBIG GESCHLIFFEN
PÂTE BLANCHE RECTIFIÉ







TECNOLOGIA DIGITALE
DIGITAL TECHNOLOGY
DIGITAL TECHNOLOGIE
TECHNOLOGIE NUMÉRIQUE

FASCE PREZZO | PRICE RANGE | PREISGRUPPE | NIVEAU DE PRIX

■ FASCIA PREZZO AL METRO QUADRATO / SQUARE METER PRICE RANGE / QUADRATMETER PREISGRUPPE / NIVEAU DE PRIX AU MÈTRE CARRÉ
▲ FASCIA PREZZO AL PEZZO / PRICE RANGE PER PIECE / STÜCK PREISGRUPPE / NIVEAU DE PRIX À LA PIÈCE

FORMATI SIZES	PEZZI SPECIALI SPECIAL PIECES					
	40x120 - 16"x48"	HIVE 40x120 - 16"x48"	FLOWERS RET 40x120 - 16"x48"	JEWEL FLOWERS 40x120 - 16"x48"	FIRMA 40x120 - 16"x48"	
	▼ 11 ▲ 11	▼ 11 ▲ 11	▼ 11 ▲ 11	▼ 11 ▲ 11	▼ 11 ▲ 11	
APUANIAN WHITE	NAT/RET	02552 ▲ 740	02556 ▲ 780	02589 ▲ 780	02648 ▲ 860	02683 ▲ 780
	LEV/RET					
IMPERIAL PEARL	NAT/RET	02553 ▲ 740	02557 ▲ 780	02589 ▲ 780	02648 ▲ 860	02684 ▲ 780
	LEV/RET					
MAJESTIC ONYX	NAT/RET	02554 ▲ 740	02558 ▲ 780	02589 ▲ 780	02648 ▲ 860	02685 ▲ 780
	LEV/RET					
SUPREME GREY	NAT/RET	02555 ▲ 740	02559 ▲ 780	02589 ▲ 780	02648 ▲ 860	02686 ▲ 780
	LEV/RET					

IMBALLI | PACKING | VERPACKUNG | EMBALLAGE

FORMATO / SIZE		MM	 PEZZI/SCATOLA PIECES/BOX STCK/KARTON CARREAUX/ BOÎTE	 MQ/SCATOLA SQMT/BOX QM/KARTON M2/BOÎTE	 KG/SCATOLA KGS/BOX KG/KARTON KG/BOÎTE	 SCATOLE/PALETTA BOXES/PALLET KARTON/PALLET BOÎTE/PALETTE	 MQ/PALETTA SQMT/PALLET QM/PALLET M2 /PALETTE	 KG/PALETTA KGS/PALLET KG/PALLET KG/PALETTE	 FORMATO PALETTA SIZE PALLET FORMAT PALLET DIM. PALETTE
119,5x119,5 LEV RET	P	9	2	2,860	55,50	22	62,92	1221	132x132x53
60x119,5 NAT RET	P	9,5	2	1,434	31	30	43,02	930	120x80x75
60x119,5 LEV RET	P	9,5	2	1,434	32	30	43,02	960	120x80x75
60x60 NAT RET	P	9,5	3	1,080	21,50	40	43,20	860	120x80x75
60x60 LEV RET	P	9,5	3	1,080	22,50	40	43,20	900	120x80x75
30x60 NAT RET	P	9,5	6	1,080	21,50	48	51,84	1032	120x80x75
30x60 LEV RET	P	9,5	6	1,080	22,50	48	51,84	1080	120x80x75
10x53 NAT	P	9,5	12	0,636	13,20	60	38,16	792	120x80x75
10x53 LEV	P	9,5	12	0,636	13,20	60	38,16	792	120x80x75
60x119,5 MIX ART LEV	P	9,5	2	1,434	32	30	43,02	960	120x80x75
60x119,5 ABBEY ROAD	P	9,5	2	1,434	32	15			
60x119,5 JUNGLE	P	9,5	2	1,434	32	15			
30x60 EMBEDDED	P	9,5	6	1,080	22,50	48			
30x60 FIRMA	P	9,5	1	0,180	3,75	20			
30x119,5 STRIPES	P	9,5	4	1,434	31	36	51,62	1,116	95x122x70
30x119,5 VELVET	P	9,5	4	1,434	31	36	51,62	1,116	95x122x70
7,5x30 BRICK STRIPES	P	9,5	22	0,495	10,50	96			
7,5x30 BRICK VELVET	P	9,5	22	0,495	10,50	96			
7,5x30 BRICK	P	9,5	22	0,495	10,50	96			
34x36 HEXAGON	P	9,5	6	0,734	15,30	40			
28x32,5 ARROWS	P	9,5	6	0,546	11,50	54			
31x35 NET	P	9,5	6	0,651	13,56	40			
30x30 CUBE	P	9,5	5	0,450	8	54			
30x30 MOSAICO JUNGLE	P	9,5	6	0,540	10,20	54			
40x120 NAT RET	P	11	3	1,440	28,25	20	28,80	565	120x80x60
40x120 HIVE	P	11	3	1,440	28,25	20	28,80	565	120x80x60
40x120 FLOWERS	P	11	3	1,440	28,25	20			
40x120 JEWEL FLOWERS	P	11	2	0,960	20,30	18			
40x120 FIRMA	P	11	1	0,480	9,40	20			
PEZZI SPECIALI / SPECIAL PIECES									
30x60 GRADINO NAT-LEV RET	P	9,5	6	1,080	21,50	36			
30x119,5 GRADINO NAT-LEV RET	P	9,5	3	1,076	24	20			
8x60 BATT. NAT-LEV RET	P	9,5	10	0,480 m.l. 6,00	11	72			
6,5x119,5 BATT. NAT-LEV RET	P	9,5	8	0,621 m.l. 9,60	12,50	48			

MAJESTIC | PEZZI SPECIALI

SPECIAL PIECES
FORMSTÜCKE
PIÈCES SPÉCIALES

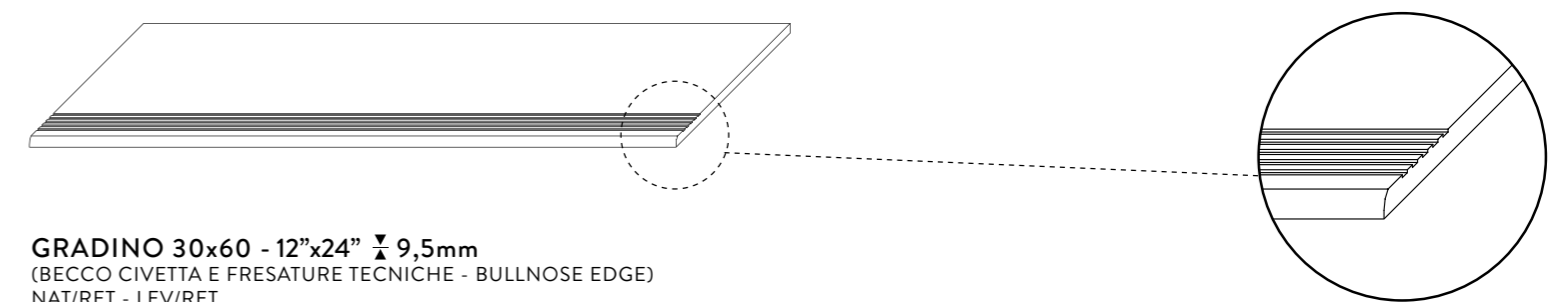
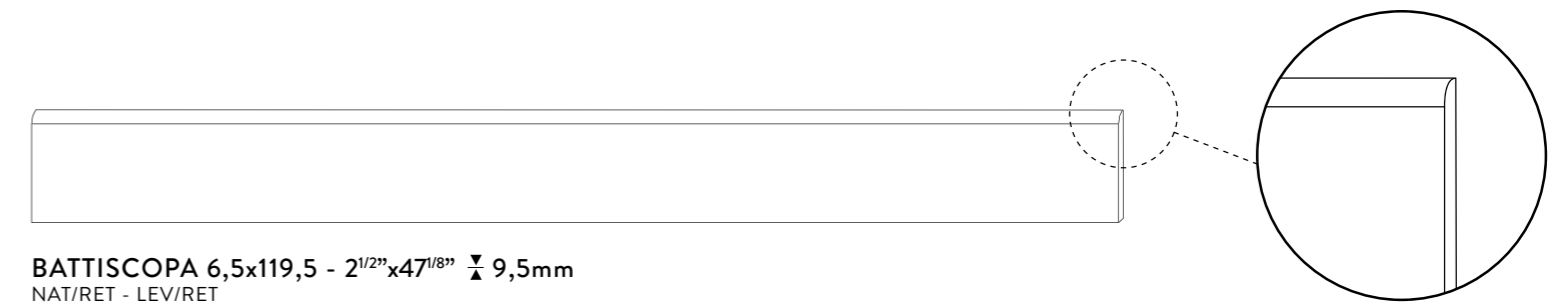
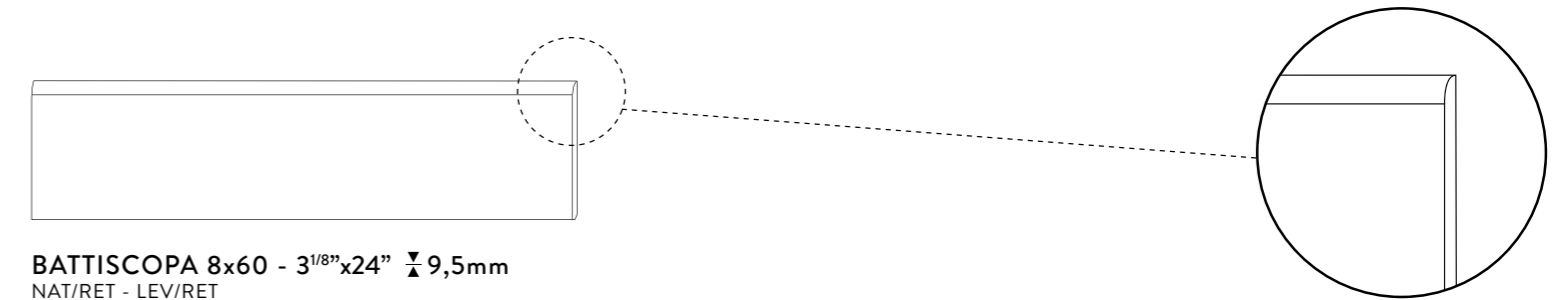

CARATTERISTICHE TECNICHE | TECHNICAL CHARACTERISTICS

GRES FINE PORCELLANATO
FINE PORCELAIN STONEWARE
FEINSTEINZEUG
GRÈS CÉRAME FIN

CLASSIFICAZIONE SECONDO NORME CEN/ISO GRUPPO B1A EN 14411 - ISO 13006
CLASSIFICATION IN ACCORDANCE WITH CEN/ISO STANDARDS B1A EN 14411 - ISO 13006
KLASSIFIZIERUNG GEMÄSS CEN/ISO-NORMEN GRUPPE B1A EN 14411 - ISO 13006
CLASSIFICATION SELON LES NORMES CEN/ISO GROUPE B1A EN 14411 - ISO 13006

CARATTERISTICA TECNICA TECHNICAL CHARACTERISTIC TECHNISCHE DATE CARACTÉRISTIQUE TECHNIQUE	NORMA NORM NORME	VALORE PRESCRITTO VALUE REQUIRED NORMVORGABE VALEUR PRESCRITE	VALORE MEDIO MEAN VALUE MITTELWERT VALEUR MOYENNE	USA TESTS	VALORE MEDIO MEAN VALUE MITTELWERT VALEUR MOYENNE
LUNGHEZZA E LARGHEZZA LENGHT AND WIDTH / LANGE UND BREITE / LONGUEUR ET LARGEUR		±0,6% (±2,00 MM)			
SPESORE THICKNESS / STÄRKE / ÉPAISSEUR		±5% (±0,5 MM)			
RETLINĒITĀ LATI WARPAGES OF EDGES / GERADHEIT DER KANTEN / RÉCTITUDE DES ARÊTES	ISO 10545.2	±0,5% (±1,5 MM)	CONFORME IN ACCORDANCE ERFÜLLT CONFORME	ASTM C-499 ASTM C-485 ASTM C-502	IN ACCORDANCE
ORTOGONALITÀ WEDGING / RECHTWINKLIGKEIT / ORTHOGONALITÉ		±0,5% (±2,00 MM)			
PLANARITÀ FLATNESS / PLANITĀT / PLANIMÉTRIE		±0,5% (±2,00 MM)			
ASSORBIMENTO % D'ACQUA WATER ABSORPTION WASSERAUFNAHME % ABSORPTION D'EAU %	ISO 10545.3	≤ 0,5%	CONFORME IN ACCORDANCE ERFÜLLT CONFORME	ASTM C-373	IN ACCORDANCE
RESISTENZA ALLA FLESSIONE BENDING STRENGTH BIEGEZUGFESTIGKEIT RÉSISTANCE À LA FLEXION	ISO 10545.4	≥ 35N/MM²	CONFORME IN ACCORDANCE ERFÜLLT CONFORME	ASTM C-648 250 LBS OR GREATER	IN ACCORDANCE
DILATAZIONE TERMICA LINEARE TRA 20° E 100° C LINEAR THERMAL EXPANSION BETWEEN 20° AND 100° C LINEARE WÄRMEAUSENDHUNG ZWISCHEN 20° UND 100° C DILATATION THERMIQUE LINEAIRE ENTRE 20° ET 100° C	ISO 10545.8	SECONDO I DATI DEL COSTRUTTORE ACCORDING TO BUILDER'S SPECIFICATIONS LAUT ANGABEN DES HERSTELLERS SELON LES ELEMENTS DU COSTRUCTEUR	± 7X10 ⁻⁶ C ⁻¹		
RESISTENZA AGLI SBALZI TERMICI THERMAL SHOCK RESISTANCE TEMPERATURWECHSELBESTÄNDIGKEIT RÉSISTANCE AUX ÉCARTS DE TEMPÉRATURE	ISO 10545.9	RICHIESTA REQUEST BITTE DEMANDE	RESISTENTE RESISTANT WIDERSTEHEND RÉSISTANT		
RESISTENZA AL GELO FROST RESISTANCE FROSTBESTÄNDIGKEIT RÉSISTANCE AU GEL	ISO 10545.12	RICHIESTA REQUEST BITTE DEMANDE	RESISTENTE RESISTANT WIDERSTEHEND RÉSISTANT	ASTM C-1026	IN ACCORDANCE
RESISTENZA ALL'ATTACCO CHIMICO RESISTANCE TO CHEMICAL ATTACK BESTÄNDIGKEIT GEGEN CHEMIKALIEN RÉSISTANCE À L'ATTACQUE CHIMIQUE	ISO 10545.13	SECONDO I DATI DEL COSTRUTTORE ACCORDING TO BUILDER'S SPECIFICATIONS LAUT ANGABEN DES HERSTELLERS SELON LES ELEMENTS DU COSTRUCTEUR	RESISTENTE RESISTANT WIDERSTEHEND RÉSISTANT	ASTM C-650	IN ACCORDANCE
RESISTENZA DEI COLORI ALLA LUCE COLOURS RESISTANCE TO LIGHT LICHTBESTÄNDIGKEIT RÉSISTANCE DES COULEURS À LA LUMIÈRE	DIN 51094	NESSUNA ALTERAZIONE NO ALTERATION KEINE VERÄNDERUNG AUCUNE ALTÉRATION	CONFORME IN ACCORDANCE ERFÜLLT CONFORME		
RESISTENZA ALLE MACCHIE STAIN RESISTANCE FLECKENFESTIGKEIT RÉSISTANCE AUX TACHES	ISO 10545.14	≥ CLASSE 3 METODO DI PROVA DISPONIBILE TEST METHOD AVAILABLE VERFÜGBARE PRÜFMETHODE METHODE D'ESSAI DISPONIBLE	CONFORME IN ACCORDANCE ERFÜLLT CONFORME		
RESISTENZA ALLO SCIVOLAMENTO SLIPPAGE RESISTANCE RUTSCHSICHERHEIT RÉSISTANCE AU GLISSEMENT	DIN 51130 *	9 ≤ R ≤ 13	NAT	R9 ASTM C-1028 * COF ≥ 0,6 DRY ≥ 0,6 WET	NAT
	DIN 51097 *	A,B,C	NAT	A ANSI * 137.1-2012 DCOF > 0,42 WET	NAT > 0,42
PENDULUM SLIP TEST	BS EN 7976-2*	> 36 DRY > 36 WET	NAT		

*TRATTANDOSI DI NORMATIVE NAZIONALI, I METODI DI PROVA, I REQUISITI E LE CLASSIFICAZIONI VARIANO DA PAESE A PAESE. IL VALORE ATTESO DALLA RESISTENZA ALLO SCIVOLAMENTO DELLA PRODUZIONE DI INDUSTRIE CERAMICHE PIEMME S.P.A., PUÒ VARIARE IN BASE AL LOTTO PRODUTTIVO. SPECIFICA DOCUMENTAZIONE È DISPONIBILE SU RICHIESTA.
TEST METHODS, REQUIREMENTS AND CLASSIFICATIONS DIFFER FROM COUNTRY TO COUNTRY, ACCORDING TO THE NATIONAL REGULATIONS. THE EXPECTED VALUE OF SLIPPAGE RESISTANCE OF PRODUCTS BY INDUSTRIE CERAMICHE PIEMME S.P.A. MAY VARY DEPENDING ON THE PRODUCTION BATCH. SPECIFIC DOCUMENTS ARE AVAILABLE UPON REQUEST.
PRÜFVERFAHREN, ERFORDERNISSE UND KLASSIFIKATIONEN SIND VERSCHIEDEN VON LAND ZU LAND, GEMÄSS DER NATIONALEN VORSCHRIFTEN. DER ERWARTUNGSWERT DER RUTSCHSICHERHEIT DER PRODUKTE VON INDUSTRIE CERAMICHE PIEMME S.P.A. KANN SICH - JE NACH DER PRODUKTIONSPARTIE - VERÄNDERN. SPEZIFISCHE UNTERLAGEN SIND AUF VERLANGEN ZUR VERFÜGUNG.
LES MÉTHODES D'ESSAI, LES RÉQUISITIONS ET LES CLASSIFICATIONS CHANGENT DE PAYS À PAYS, SELON LES RÉGLEMENTATIONS NATIONALES. LA VALEUR ATTENDUE DE RÉSISTANCE AU GLISSEMENT DES PRODUITS DE INDUSTRIE CERAMICHE PIEMME S.P.A. PEUT VARIER EN FONCTION DU LOT DE PRODUCTION. UNE DOCUMENTATION SPÉCIFIQUE EST DISPONIBLE SUR DEMANDE.

ELENCO DELLE SERIE CERTIFICATE E CLASSIFICAZIONI DISPONIBILI A RICHIESTA - LIST OF CERTIFIED SERIES AND CLASSIFICATIONS AVAILABLE UPON REQUEST
LISTE DER GEPRÜFTEN SERIE UND KLASSIFIZIERUNGEN AUF ANFRAGE ERHÄLTICH - LISTE DES SERIES CERTIFIÉES ET DES CLASSEMENTS DISPONIBLES SUR DEMANDE



CARATTERISTICHE TECNICHE | TECHNICAL CHARACTERISTICS

PASTA BIANCA
WHITE BODY
WEIßHERBIG
PÂTE BLANCHE

CLASSIFICAZIONE SECONDO NORME CEN/ISO GRUPPO BIII EN 14411/ISO 13006
CLASSIFICATION IN ACCORDANCE WITH CEN/ISO STANDARDS BIII EN 14411/ISO 13006
KLASSIFIZIERUNG GEMÄSS CEN/ISO-NORMEN GRUPPE BIII EN 14411/ISO 13006
CLASSIFICATION SELON LES NORMES CEN/ISO GROUPE BIII EN 14411/ISO 13006

*VALORE PRESCRITTO: EN 14411 APPENDICE L ISO 13006 BIII
*REQUIRED VALUE: EN 14411 APPENDICE L ISO 13006 BIII
*VORGESCHRIEBENER WERT: EN 14411 APPENDICE L ISO 13006 BIII
*VALEUR PRESCRITE: EN 14411 APPENDICE L ISO 13006 BIII

CARATTERISTICA TECNICA TECHNICAL CHARACTERISTIC TECHNISCHE DATE CARACTÉRISTIQUE TECHNIQUE	NORMA NORM NORME	VALORE PRESCRITTO (N≥15 CM)* REQUIRED VALUE VORGESCHRIEBENER WERT VALEUR PRESCRITE	VALORE STANDARDS ERGEBNIS VALEUR
LUNGHEZZA E LARGHEZZA LENGHT AND WIDTH / LANGE UND BREITE / LONGUEUR ET LARGEUR		± 0,5%	± 0,5%
SPESORE THICKNESS / STÄRKE / ÉPAISSEUR		± 10%	CONFORME IN ACCORDANCE ERFÜLLT CONFORME
ORTOGONALITÀ WEDGING / RECHTWINKLIGKEIT / ORTHOGONALITÉ	ISO 10545.2	± 0,5%	± 0,5%
PLANARITÀ FLATNESS / EBENFLÄCHIGKEIT / PLANÉITÉ		+ 0,5% - 0,3%	+ 0,5% - 0,3%
ASSORBIMENTO D'ACQUA WATER ABSORPTION WASSERAUFNAHME ABSORPTION D'EAU	ISO 10545.3	> 10%	± 16%
RESISTENZA A FLESSIONE FLEXION RESISTANCE BIEGUNGSPFESTIGKEIT RÉSISTANCE À LA FLEXION ÉPAISSEUR	ISO 10545.4	≥ 7,5MM < 7,5MM	12 N/MM² 15 N/MM²
COEFFICIENTE DI DILATAZIONE TERMICA LINEARE COEFFICIENT OF LINEAR THERMAL-EXPANSION LINEARE WÄRMEAUSENDHUNG COEFFICIENT LINEAIRE DE DILATATION THERMIQUE	ISO 10545.8	SECONDO I DATI DEL COSTRUTTORE ACCORDING TO BUILDER'S SPECIFICATIONS LAUT ANGABEN DES HERSTELLERS SELON LES ELEMENTS DU COSTRUCTEUR	± 6x10 ⁻⁶ K ⁻¹
RESISTENZA AGLI SBALZI TERMICI THERMAL SHOCK RESISTANCE TEMPERATURWECHSELBESTÄNDIGKEIT RÉSISTANCE AUX ÉCARTS DE TEMPÉRATURE	ISO 10545.9	METODO DI PROVA DISPONIBILE TEST METHOD AVAILABLE VERFÜGBARE PRÜFMETHODE METHODE D'ESSAI DISPONIBLE	GUARANTITA GUARANTEED GARANTIE GARANTIE
RESISTENZA AL GELO FROST RESISTANCE FROSTBESTÄNDIGKEIT RÉSISTANCE AU GEL	ISO 10545.12	METODO DI PROVA DISPONIBILE TEST METHOD AVAILABLE VERFÜGBARE PRÜFMETHODE METHODE D'ESSAI DISPONIBLE	NO NO NEIN NEIN
RESISTENZA AI PRODOTTI CHIMICI CHEMICAL RESISTANCE CHEMIKALIENFESTIGKEIT RÉSISTANCE AUX PRODUITS CHIMIQUES	ISO 10545.13	METODO DI PROVA DISPONIBILE TEST METHOD AVAILABLE VERFÜGBARE PRÜFMETHODE METHODE D'ESSAI DISPONIBLE	DISPONIBILE SU RICHIESTA AVAILABLE ON REQUEST VERFÜGBARE AUF ANFRAGE DISPONIBLE SUR DEMANDE
RESISTENZA AL CAVILLO CRAZING RESISTANCE HAARISSBESTÄNDIGKEIT RÉSISTANCE AU TRESSAILLAGE	ISO 10545.11	RICHIESTA REQUIRED ERFORDERLICH REQUIRE	GUARANTITA GUARANTEED GARANTIE GARANTIE

*TRATTANDOSI DI NORMATIVE NAZIONALI, I METODI DI PROVA, I REQUISITI E LE CLASSIFICAZIONI VARIANO DA PAESE A PAESE. IL VALORE ATTESO DALLA RESISTENZA ALLO SCIVOLAMENTO DELLA PRODUZIONE DI INDUSTRIE CERAMICHE PIEMME S.P.A., PUÒ VARIARE IN BASE AL LOTTO PRODUTTIVO. SPECIFICA DOCUMENTAZIONE È DISPONIBILE SU RICHIESTA.
TEST METHODS, REQUIREMENTS AND CLASSIFICATIONS DIFFER FROM COUNTRY TO COUNTRY, ACCORDING TO THE NATIONAL REGULATIONS. THE EXPECTED VALUE OF SLIPPAGE RESISTANCE OF PRODUCTS BY INDUSTRIE CERAMICHE PIEMME S.P.A. MAY VARY DEPENDING ON THE PRODUCTION BATCH. SPECIFIC DOCUMENTS ARE AVAILABLE UPON REQUEST.
PRÜFVERFAHREN, ERFORDERNISSE UND KLASSIFIKATIONEN SIND VERSCHIEDEN VON LAND ZU LAND, GEMÄSS DER NATIONALEN VORSCHRIFTEN. DER ERWARTUNGSWERT DER RUTSCHSICHERHEIT DER PRODUKTE VON INDUSTRIE CERAMICHE PIEMME S.P.A. KANN SICH - JE NACH DER PRODUKTIONSPARTIE - VERÄNDERN. SPEZIFISCHE UNTERLAGEN SIND AUF VERLANGEN ZUR VERFÜGUNG.
LES MÉTHODES D'ESSAI, LES RÉQUISITIONS ET LES CLASSIFICATIONS CHANGENT DE PAYS À PAYS, SELON LES RÉGLEMENTATIONS NATIONALES. LA VALEUR ATTENDUE DE RÉSISTANCE AU GLISSEMENT DES PRODUITS DE INDUSTRIE CERAMICHE PIEMME S.P.A. PEUT VARIER EN FONCTION DU LOT DE PRODUCTION. UNE DOCUMENTATION SPÉCIFIQUE EST DISPONIBLE SUR DEMANDE.

ELENCO DELLE SERIE CERTIFICATE E CLASSIFICAZIONI DISPONIBILI A RICHIESTA - LIST OF CERTIFIED SERIES AND CLASSIFICATIONS AVAILABLE UPON REQUEST
LISTE DER GEPRÜFTEN SERIE UND KLASSIFIZIERUNGEN AUF ANFRAGE ERHÄLTICH - LISTE DES SERIES CERTIFIÉES ET DES CLASSEMENTS DISPONIBLES SUR DEMANDE



NORME PER LA POSA E LA MANUTENZIONE

- Per i prodotti rettificati consigliamo una fuga di 2 mm per un migliore risultato di posa.
 - Per una migliore resa estetica Piemme consiglia stuccature colorate in tinta con le piastrelle.
 - Verificare, prima dell'utilizzo, la compatibilità ed idoneità dei riempitivi per fughe con il prodotto ceramico.
 - Rimuovere le eccedenze dei riempitivi per fughe quando gli stessi sono ancora freschi.
 - Attenersi scrupolosamente alle istruzioni indicate dai produttori dei riempitivi per fughe.

- Per eliminare completamente i residui di posa, che potrebbero compromettere la manutenzione ordinaria e le caratteristiche del prodotto, a posa ultimata, procedere con la pulizia utilizzando prodotti adeguati, a base Acida max 3%, rispettando le indicazioni del produttore. Osservare assolutamente i limiti di tempo indicati nelle istruzioni: un contatto troppo prolungato con questi prodotti potrebbe provocare il danneggiamento della superficie.

- Gli eventuali aloni che si dovessero presentare dopo la posa di materiali lappati o levigati si potranno facilmente eliminare utilizzando un prodotto idoneo, a base Alcalina.

- Riguardo l'utilizzo di materiali ceramici all'esterno, pure riconfermando l'ingelività dei prodotti Piemme in gres porcellanato, in conformità alle vigenti normative europee EN 14411/ISO 13006-ISO 10545.12, occorre attenersi ad alcune fondamentali norme previste per la posa all'esterno, atte a rendere inattuacabili al gelo i predetti pavimenti. Le condizioni più importanti da rispettare sono: le opportune pendenze, le impermeabilizzazioni, i giunti di dilatazione, e l'uso di idonei materiali per la posa.

- Decorazioni realizzati con smalti e metalli preziosi È indispensabile proteggere la superficie durante la posa, non utilizzare assolutamente prodotti abrasivi e/o acidi, ma solo acqua e sapone neutro. Il produttore non risponde di eventuali danni a questi preziosi materiali causati da "sfregamenti" durante la posa in opera. Per nessun motivo saranno accettate contestazioni relative a materiale posato.

TIPO DI SPORCO	INDICAZIONI PER LA PULIZIA
Birra, Caffè, Gelato, Vino Gomma Pneumatico, Grassi vegetali e animali, Inchiostri, Lampostil Olii Meccanici, Residui di scotch Olio di lino, PennarelloResine Smalti, Tintura per capelli	Prodotti a Base Alcalina
Cera protettiva anti-abrasione, Depositi calcarei, Macchie di ruggine	Prodotti a Base Acida
Cera di candela, Residui di scotch	Solventi

Per ulteriori informazioni specifiche consultare l'area tecnica sul sito Piemme:

www.ceramichepiemme.it

- For better installation results of rectified products, we suggest 2 mm joint. - For a better aesthetic finish, Piemme recommends using jointing colours that match the tiles. - Please check, before using, the compatibility and suitability of grouting material with the ceramic tile. - Clean away the excess of grouting materials while they are still fresh. - Follow carefully the instructions pointed out by the producers of tile grouting materials.	- To completely eliminate installation residues, which could negatively affect routine maintenance and product characteristics once installation has terminated, proceed to clean using adequate products, with max. 3% Acid base, following the manufacturer's instructions. Always closely abide by the time limits indicated in the instructions: prolonged contact with these products may cause damage to the surface. - Any rims that appear after installing lapped or polished materials can be easily eliminated using a suitable Alkaline-based product.	- With regard to the use of ceramic materials outdoors, while once more reiterating that Piemme porcelain stoneware products are frost-proof, in compliance with applicable European standards EN 14411/ISO 13006-ISO 10545.12, a number of fundamental procedures must be followed for outdoor installation, suitable for making the aforementioned floors resistant to frost. The most important aspects are: suitable gradients, waterproofing, expansion joints, and the use of suitable installation materials. - Decorations made with glazes and precious metals It is most important to protect the surface during installation. Never use abrasive and/or acid products, only water and neutral soap. The manufacturer disclaims liability in case of any damage to these precious materials caused by "rubbing" during installation. Under no circumstances will disputes be accepted relating to the installed material.	TYPE OF STAIN beer, coffee, wine, ice cream vegetable and animal fats, rubber, remains of scotch tape, grease from machines, linseed oil, felt tip pens, paints, inks, hair dye protective anti-abrasion wax, calcareous residuals, rust stains candle wax, remains of scotch-tape
			CLEANING SUGGESTIONS Alkaline-based detergent Acid-based detergent Solvent
			For further specific details please visit the technical area on Piemme website: www.ceramichepiemme.it

- Damit sich eine bessere Verlegung von geschliffenen Produkten ergibt, empfehlen wir eine Fugenbreite von 2 mm.
 - Für ein optisch perfektes Ergebnis empfiehlt Piemme, die Fugen farblich auf die Fliesen abzustimmen.
 - Prüfen sie bitte, vor der Verwendung, die Zweckmäßigkeit und die Verträglichkeit des Fugenfüllmittels mit den Keramikfliesen.
 - Bitte entfernen sie das überflüssige Fugenfüllmittel wenn es noch frisch ist.
 - Folgen sie bitte sorgfältig die von dem Herstellern des Fugenfüllmittels angegebenen Bedienungsvorschriften.

- Zur vollkommenen Entfernung der Verlegerückstände, die die normale Pflege erschweren und die Merkmale des Produkts beeinträchtigen könnten, nach der Verlegung geeignete Reinigungsmittel auf max. 3% Säurebasis verwenden und bei der Reinigung die Hinweise des Herstellers beachten. Die angegebenen Zeiten keinesfalls überschreiten: ein zu lange andauernder Kontakt mit diesen Produkten kann Beschädigungen der Oberfläche verursachen.
 - Eventuelle nach der Verlegung von geläpptem oder geschliffenem Material sichtbare Schleier lassen sich einfach mit entsprechenden, alkalischen Produkten entfernen.

- Auch wenn die Piemme-Feinsteinzeugprodukte gemäß den europäischen Normen EN 14411/ISO 13006-ISO 10545.12 frostbeständig sind, müssen beim Einsatz keramischer Materialien im Freien einige Grundregeln beachtet werden, damit die Bodenbeläge nicht vom Frost angegriffen werden können. Die wichtigsten Voraussetzungen sind: korrektes Gefälle, Abdichtung, Dehnungsfugen sowie geeignetes Verlegematerial.
 - Dekore mit Glasuren und Edelmetallen Während der Verlegung muss die Oberfläche unbedingt abgedeckt werden. Es dürfen keine scheuernden und/oder säurehaltigen Produkte verwendet werden, sondern ausschließlich Wasser und neutrale Seife. Der Hersteller haftet nicht für eventuelle, während der Verlegung durch Abrieb entstandene Schäden an diesen hochwertigen Materialien. Reklamationen von bereits verlegtem Material werden in keinem Fall akzeptiert.

VERSCHMUTZUNGSART	REINIGUNGSHINWEISE
Bier, Wein, Eis, Kaffee Tierische oder pflanzliche Fette Gummi, Kleberbandresten Schmieröl, Tinte, Leöl, Filzstift, Harz oder Lack, Haarfarbe	Alkalische Reinigungsmittel
Kratzenschutz-Wachs, Kalkablagerunge, Rostflecken	Säure-Reinigungsmittel
Kerzenwachs Kleberbandresten	Lösungsmittel

Weitere Einzelheiten finden Sie in dem technischen Bereich des Piemme Website:

www.ceramichepiemme.it

- Pour obtenir le meilleur résultat de pose de produits rectifiés, il est conseillé de réaliser un joint de 2 mm.
 - Pour parfaire l'effet esthétique obtenu, Piemme conseille de confectionner des joints de la même couleur que les carreaux.
 - Vérifier avant la pose la compatibilité et convenance des remplissages pour joints avec le produit céramique.
 - Enlever les surplus des remplissages pour joints alors qu'ils sont encore frais.
 - Respecter scrupuleusement les instructions indiquées par les fabricants de remplissages pour joints.

- Pour éliminer complètement tout résidu de pose pouvant gêner l'entretien courant et altérer les caractéristiques du produit, il est conseillé, à la fin de la pose, de procéder au nettoyage du carrelage avec des produits à base acide maximum 3% et de respecter les consignes du fabricant. Suivre impérativement les délais indiqués dans la notice car le contact trop prolongé de ces produits pourrait endommager la surface.
 - Pour éliminer facilement la présence éventuelle de cernes après la pose de carreaux rodés ou polis, utiliser un produit à base alcaline.

- Pour ce qui est de la pose à l'extérieur, bien que les produits Piemme en grès cérame soient ingélifs, conformément aux normes européennes EN 14411/ISO 13006-ISO 10545.12, il convient cependant de respecter quelques règles fondamentales de manière à rendre le carrelage inattaquable au gel. Les conditions les plus importantes à remplir sont: le degré d'inclinaison, l'imperméabilisation, les joints de dilatation et l'utilisation de matériaux de pose appropriés.
 - Décors réalisés avec des émaux et des métaux précieux Il est indispensable de protéger la surface pendant la pose. N'utiliser en aucun cas des produits abrasifs et/ou acides mais uniquement de l'eau et du savon neutre. La fabricant ne répond pas des dommages éventuels de ces matériaux précieux causés par le frottement pendant la pose. Aucune réclamation, quelle qu'elle soit, concernant le matériau posé ne sera acceptée.

TYPE DE TACHE	NETTOYAGE CONSEIL
Bière, Vin, Glace, Café, Graisses végétales et animales, Encres, Résidus de scotch, Huile de graissage, Hile de lin Crayon feutre Emaux, Teinture pour cheveux, Caoutchouc pour pneus	Détergents à base alcaline
Cire de protection anti abrasion, Dépôts de calcare, Tache de rouille	Détergents à base d'acide
Cire de bougie Résidus de scotch	Solvant

Pour d'ultérieures informations spécifiques consulter le département technique du site Piemme:

www.ceramichepiemme.it

GUIDA ALLA LETTURA

READING GUIDE | LESEANLEITUNG | GUIDE A LA LECTURE

▼ **SPESSORE**
THICKNESS
▲ STÄRKE
EPAISSEUR

P GRES FINE PORCELLANATO
PORCELAIN STONWARE
FEINSTEINZEUG
GRÈS CÉRAME

PB PASTA BIANCA
WHITE BODY
WEIßSCHERBIG
PÂTE BLANCHE

490 FASCIA PREZZO AL METRO QUADRATO
SQUARE METER PRICE RANGE
QUADRATMETER PREISGRUPPE
NIVEAU DE PRIX AU MÈTRE CARRÉ

90 FASCIA PREZZO AL PEZZO
PRICE RANGE PER PIECE
STÜCK PREISGRUPPE
NIVEAU DE PRIX À LA PIECE

VARIAZIONE NELLE SFUMATURE DI COLORE
COLOR SHADE VARIATIONS
VARIATION DER FARBNUANCEN
VARIATION DES NUANCES DE COULEUR

V1 ASPETTO UNIFORME
UNIFORM APPERANCE
GLEICHFÖRMIGES AUSSEHEN
ASPECT UNIFORME

V2 VARIAZIONE LEGGERA
SLIGHT VARIATION
LEICHTE VARIATION
LÉGÈRE VARIATION

V3 VARIAZIONE MODERATA
MODERATE VARIATION
MÄßIGE VARIATION
VARIATION MODESTE

V4 VARIAZIONE CASUALE
RANDOM VARIATION
ZUFÄLLIGE VARIATION
VARIATION FORTUITE

III PEI III
RESISTENZA ALL'ABRASIONE
SURFACE RESISTANCE
BESTIMMUNG DES WIDERSTANDES
GEGEN VERSCHLEIß
RÉSISTANCE À L'ABRASION

IV PEI IV
RESISTENZA ALL'ABRASIONE
SURFACE RESISTANCE
BESTIMMUNG DES WIDERSTANDES
GEGEN VERSCHLEIß
RÉSISTANCE À L'ABRASION

V PEI V
RESISTENZA ALL'ABRASIONE
SURFACE RESISTANCE
BESTIMMUNG DES WIDERSTANDES
GEGEN VERSCHLEIß
RÉSISTANCE À L'ABRASION

Certificazioni
Certifications
Prüfzeugnisse
Certifications



Resistenza alla scivolosità
Skid resistance
Rutschfestigkeit
Resistance au glissement

DIN 51130	DIN 51097	DCOF
R11	A+B+C	>0,42

TUTTI I FORMATI SONO NOMINALI.

ALL SIZES ARE NOMINAL.

DIE FORMATE SIND NENNWERTE.

TOUS LE FORMATS SONT NOMINAUX.

ВСЕ ФОРМАТЫ ЯВЛЯЮТСЯ НОМИНАЛЬНЫМИ.

GLI SPESSORI RIPORTATI IN QUESTO CATALOGO SONO NOMINALI E POSSONO VARIARE A SECONDA DEI FORMATI E DELLE FINITURE.

THE THICKNESSES MENTIONED ON THIS CATALOGUE ARE NOMINAL AND CAN BE DIFFERENT ACCORDING TO THE SIZES AND THE FINISHES.

DIE IN DIESEM KATALOG ANGEGEBENEN FLIENENSTÄRKE SIND NOMINAL UND KÖNNEN, JE NACH FORMAT ODER OBERFLÄCHE, VERSCHIEDEN SEIN.

LES ÉPAISSEURS REPORTÉES SUR CE CATALOGUE SONT NOMINALES ET PEUVENT VARIER SUIVANT LES FORMATS ET LES FINITIONS.

УКАЗАННАЯ В ДАННОМ КАТАЛОГЕ ТОЛЩИНА ЯВЛЯЕТСЯ НОМИНАЛЬНОЙ И МОЖЕТ ИЗМЕНЯТЬСЯ В ЗАВИСИМОСТИ ОТ ФОРМАТОВ И ОТДЕЛОК.

I COLORI E LE CARATTERISTICHE ESTETICHE DEI PRODOTTI SONO QUANTO PIÙ POSSIBILE VICINI A QUELLI REALI, NEI LIMITI CONSENTITI DAI PROCESSI DI STAMPA.

THE COLOURS AND APPEARANCE FEATURES OF THE PRODUCTS ARE AS CLOSE AS POSSIBLE TO REALITY, WITHIN THE LIMITATION OF THE PRINTING PROCESS.

DIE FARBEN UND DIE ÄSTHETISCHEN EIGENSCHAFTEN DER PRODUKTE ENTSPRECHEN DER WIRKLICHKEIT, INNERHALB DEN VON DEM DRUCKVERFAHREN ERLAUBTEN GRENZEN.

LES COULEURS ET LES CARACTÉRISTIQUES ESTHÉTIQUES SONT FIDÈLES AUX COULEURS ET CARACTHÉRISTIQUE RÉELLES DANS LES LIMITES DES PROCÉDÉS D'IMPRESSON.

ЦВЕТА И ЭСТЕТИЧЕСКИЕ ХАРАКТЕРИСТИКИ ИЗДЕЛИЙ МАКСИМАЛЬНО ПРИБЛИЖЕНЫ К РЕАЛЬНЫМ, В РАМКАХ ВОЗМОЖНОСТЕЙ ТИПОГРАФСКИХ ПРОЦЕССОВ.

PROJECT MANAGEMENT

MKTG PIEMME

.....

AD & GRAPHIC DESIGN

IKOS

.....

VALENTINO

BY CERAMICHE PIEMME

A BRAND OF:

INDUSTRIE CERAMICHE PIEMME S.P.A.

VIA DEL CROCIALE 42/44 - 41042 FIORANO (MO) - ITALY

TEL. +39 0536.849.111 - FAX +39 0536.849.402

WWW.CERAMICHEPIEMME.IT - INFO@CERAMICHEPIEMME.IT